

# Type 810

## Magnetic level gauges



# Magnetic level gauge

---

**Data Sheet**  
DS-MLG-810-eng  
June, 2008

## CONTENT

### Type 810

<b>General</b>	<b>2</b>
<b>Design</b>	<b>2</b>
<b>Technical coding</b>	<b>3</b>
<b>Standard Designs</b>	<b>4</b>
Metallic Versions – 304L St. St. standard	4
Metallic Versions – 316L St. St. standard	5
Metallic Versions –304L St. St. / 316L St. St. High duty	6
Plastic Versions – U-PVC/ PPH/ PVDF	7
<b>Reading systems</b>	<b>8</b>
Bi-coloured Rollers	8
Bi-coloured wafers (High temperatures)	9
Bi-coloured wafers (Low temperatures)	9
Magnetic Slider	9
Options and accessories	10
<b>Process Connexions</b>	<b>12</b>
PN 16 – 304L St. St.	12
PN 16 – 316L St. St.	13
PN 20 (ANSI 150#)– 304L St. St.	14
PN 20 (ANSI 150#)– 316L St. St.	15
PN 40 – 304L St. St.	16
PN 40 – 316L St. St.	17
PN 50 (ANSI 300#)– 304L St. St.	18
PN 50 (ANSI 300#)– 316L St. St.	19
PN 100 (ANSI 600#)– 304L St. St.	20
PN 100 (ANSI 600#)– 316L St. St.	21
PN 250 (ANSI 1500#)– 304L St. St.	22
PN 250 (ANSI 1500#)– 316L St. St.	23
PN 420 (ANSI 2500#)– 304L St. St.	24
PN 420 (ANSI 2500#)– 316L St. St.	25
PN 16/20 – U-PVC	26
PN 16/20 – POLYPROPYLENE	27
PN 16/20 – PVDF	28
TOP and BOTTOM Options	29
<b>Floats</b>	<b>30</b>
316L St. Steel Standard M1, M2	30
Titanium Gr2 M3	30
Titanium Gr2 M5	31
Titanium Gr2 M6, M7	31
Titanium Gr2 M8, M9	32
Titanium Gr2 M60, M61	32
Titanium Gr5 M10, M11	33
Titanium Gr5 M12, M13, M14, M15	33
Titanium Gr5 M20, M21, M22, M23	34
Titanium Gr5 M40, M41, M45	34
Buoyancy range	35
<b>4-20mA Level transmitter output</b>	<b>36</b>
Design	36
Housings selection	37
Transmitters range	38
Coding	39
<b>Alarm contacts</b>	<b>40</b>
Single Reed switch IP65 – S1, S6	40
Single / dual Reed switch ATEX "explosion proof" – S2, S4	40
Dual Reed switch IP65 – S3, S7	40
Basic Reed switch – S5	41
Single / dual Reed switch ATEX "I.S." – S8, S9	41
Pneumatic Switch N/O, N/F – S21, S22	41
<b>Documentations</b>	<b>42</b>

# Magnetic level gauge

## Type 810 General

The magnetic level gauge type 810 allows to measure directly liquid levels, even corrosive or dangerous, into vessels or under pressurized tanks. The design of this equipment ensures a good accuracy, an excellent reliability and a safe use.

A float equipped with a permanent magnet follows the level variation of the liquid to be measured.

Slider version: the float drives a magnetic slider which slides into a pyrex tube mounted on a graduated scale.

Wafers/rollers version: the float reverses magnetically locked bi-coloured Rollers. The red zone indicates the level of liquid in the tank

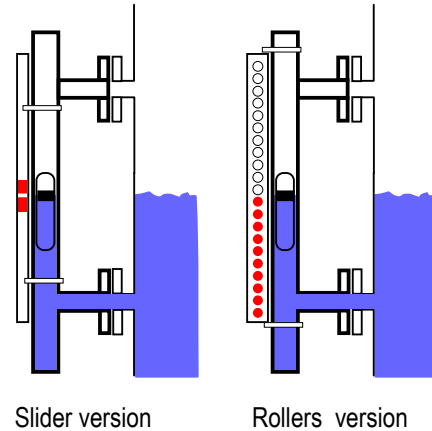

## Design

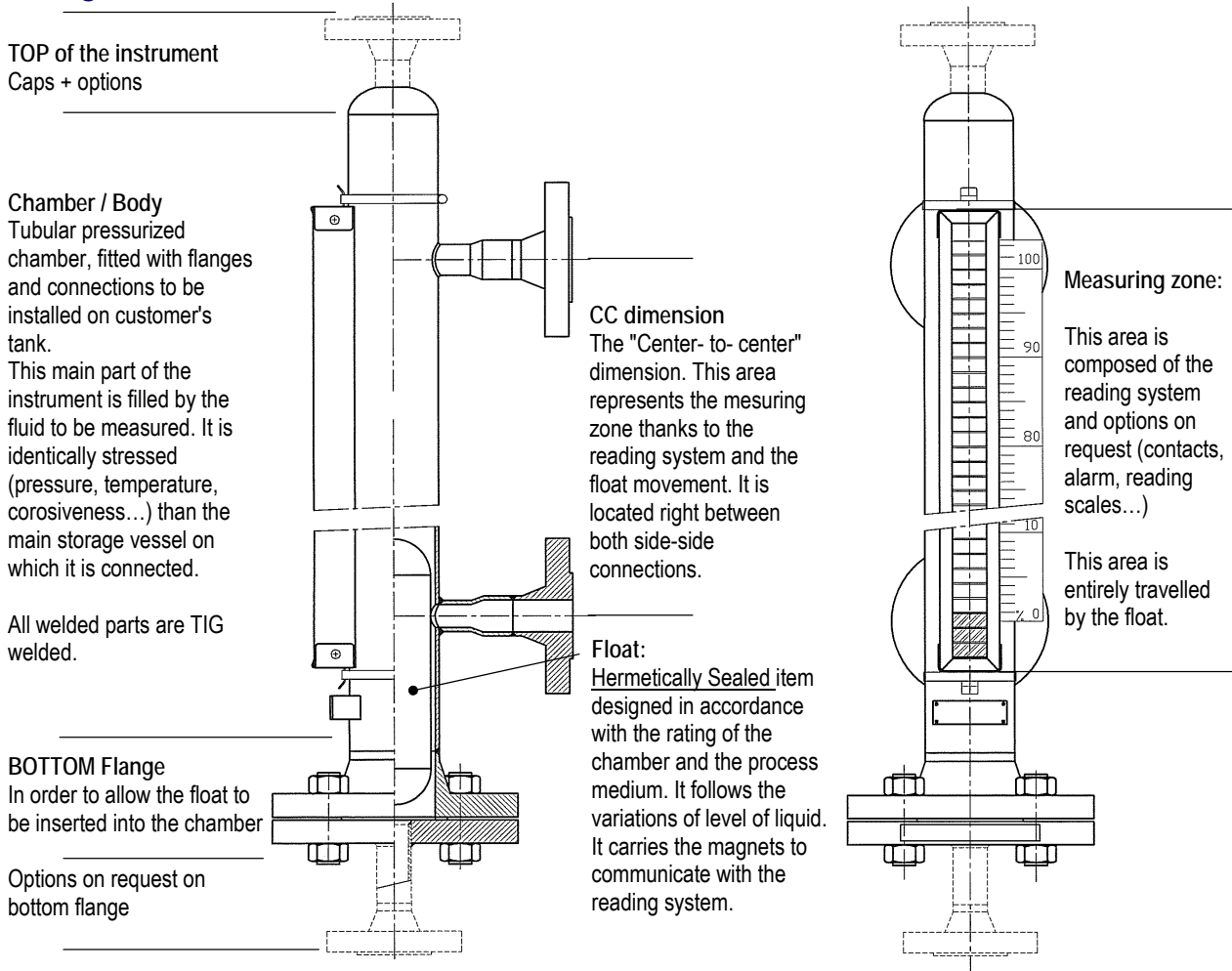

## Type 810 Technical Coding

### Plug + Vent (1/2 BSP or NPT)

For air draining according to customer process or application.  
 Many other connections types available.

### Float chamber

So called the primary tube, it consists of a stainless steel or synthetic tube fitted with flanges (in standard) for external side mounting.

### Reading system

Three versions are available according to customer's requirements:  
 S= slider  
 R= Rollers / version.  
 VA = Aluminum wafers flaps  
 Many additional options available.

### Name plate

Manufacturer name plate including all main technical data and specifications according to applicable rules and standards.

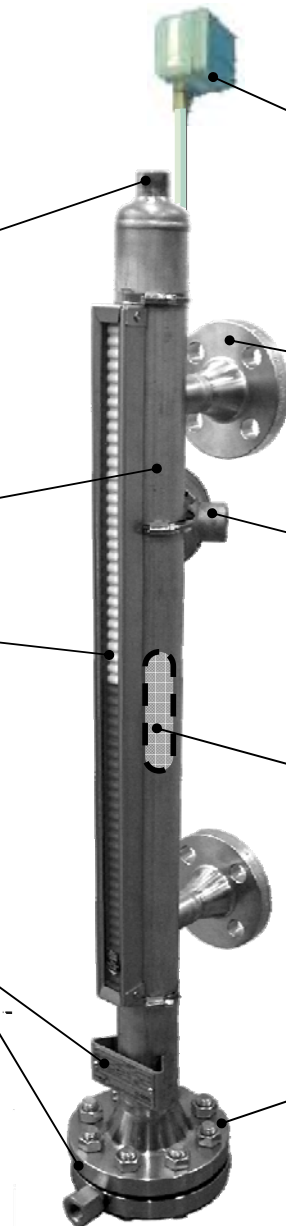

### Continuous indicator

Mc 1000 4-20mA transmitter for remote measuring.  
 Available with standard housing ,  
 ATEX I.S. (ia), or ATEX explosion-proof ("d")version.

### Process Connections

Many option for process tank connections.

### Alarm contacts

Standard mounting on the float chamber using st.st jubilee clip.  
 Standard version or ATEX I.S (ia), or flame-proof version (EEExd).

### Float

Equipped with 360°magnets – follow the variations of liquid inside the chamber.  
 Many material, magnet types and pressure rating on request.

The tube is also fitted with a **Bottom flange assembly** equipped with a drain plug.  
 Many other connections types available -

Example:

**810 S – 25 – C4 – M1-T1- S1x2 -Z4 -Z13 – D0 – 1500 – CAT/II**

Design Type	Reading system	Nominal dimension	Process connections type	Float type	Transmitter type	Alarm contact type x Quantity	Option type	Option type	Document / certificates types	Center to center dimension	PED Category
See Page 4	See Page 8	Standard ND 20,25 32,40 or ND50	See Pages 12	See Pages 30	See Page 36	See Page 40			See Page 42		CAT/0 = No PED CAT/3.3 = Art. 3§3 CAT/II = category 1 CAT/III = category 2 CAT/III = category 3 CAT/IV = category 4

# Magnetic level gauge

**Data Sheet**  
 DS-MLG-810-eng  
 June, 2008

## Type 810 Standard designs

### Metallic Versions Standard 304L Stainless Steel code C1 to C9

Chamber	Material: St. St. 304L $\varnothing$ 60,3mm x 2mm welded
TOP	Welded caps 304L Option – see page 29
BOTTOM	Flange "Brooks type D100" (Pmax = 15,9 bar @ 20°C) Drain + 1/2" NPT plug Option – see page 29
Connections	Side-Side ND 20 to 50 Flange St.St. 304L ISO/ANSI PN 20 to 50 RF 1/2 Coupling SW 3000 1/2 Coupling BSPP-F 1/2 Coupling NPT-F 3000 Tube 304L BSPP-M Tube 304L NPT-M See for connections specifications pages 12 -25
C- to- C dimension	Minimum: E= 300 mm Maximum: E= 5500 mm Longer dimensions on request (Instrument supplied with sections)
Floats	St. St. 316L titanium See for floats specifications pages 30 - 35
Reading system	R - Polyamid Rollers (PA6V) red / white VA – Aluminium red / white Wafers S – Slider Visual test of damaged float See for reading system specifications pages 8 -10
Alarm contacts	See for contacts specifications pages 40-41
Transmitter	See for transmitter specifications page 36 - 39
Reading scales	St.St. 316L/ or Aluminium Silk printed See for reading scales options page 10
<b>Process conditions</b>	
Temperature	From -160°C to + 350°C
Pressure	From -1 Atm to 32 bars
S. gravity	From 0,52 kg/m <sup>3</sup> Others on request
PED 97/23/EC	Max CAT I - Gases from group 2 only

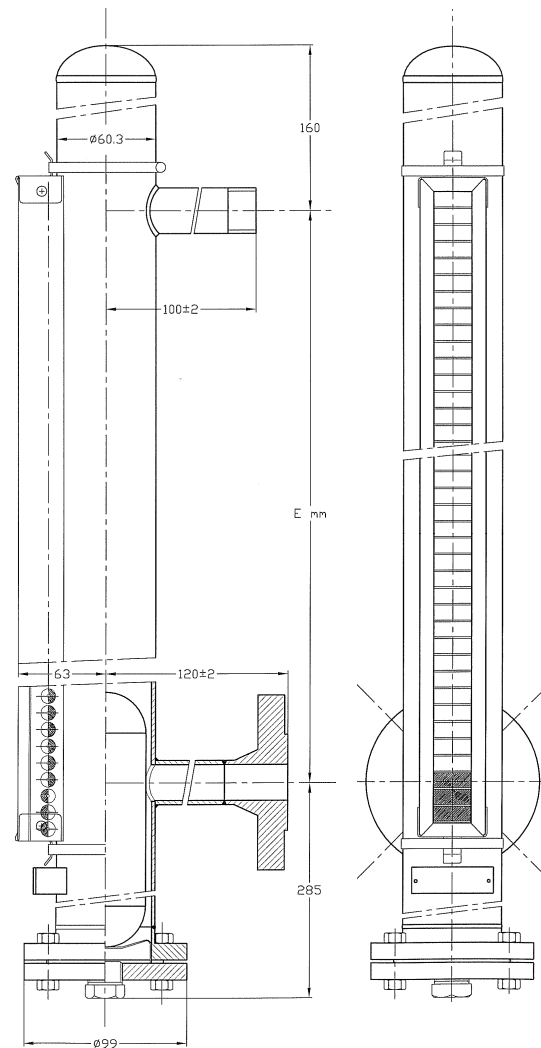

## Type 810 Standard designs

### Metallic Versions Standard 316L Stainless Steel code C11 to C19

<b>Chamber</b>	Material: St. St. 316L $\varnothing$ 60,3mm x 2mm welded
<b>TOP</b>	Welded caps 316L Option – see page 29
<b>BOTTOM</b>	Flange "Brooks type D100" (Pmax = 15,9 bar à 20°C) Drain + plug ½" NPT Option – see page 29
<b>Connections</b>	Side-Side ND 20 to 50 Flange St.St. 316L ISO/ANSI PN 20 to 50 RF ½ Coupling SW 3000 ½ Coupling BSPP-F ½ Coupling NPT-F 3000 Tube 316L BSPP-M Tube 316L NPT-M See for connections specifications pages 12 -25
<b>C- to- C dimension</b>	Minimum: E= 300 mm Maximum: E= 5500 mm Longer dimensions on request (Instrument supplied with sections)
<b>Floats</b>	St. St. 316L titanium See for floats specifications pages 30 - 35
<b>Reading system</b>	R - Polyamid Rollers (PA6V) red / white VA – Aluminium red / white Wafers S – Slider Visual test of damaged float See for reading systems specifications pages 8 -10
<b>Alarm contacts</b>	See for contacts specifications pages 40-41
<b>Transmitter</b>	See for transmitter specifications page 36 - 39
<b>Reading scales</b>	St.St. 316L or aluminium Silk printed See for reading scales options page 10
<b>Process conditions</b>	
<b>Temperature</b>	From 160°C to + 350°C
<b>Pressure</b>	From -1 Atm to 32 bars
<b>S. gravity</b>	From 0,52 kg/m <sup>3</sup> Others on request
<b>PED 97/23/EC</b>	Max CAT I - Gases from group 2 only

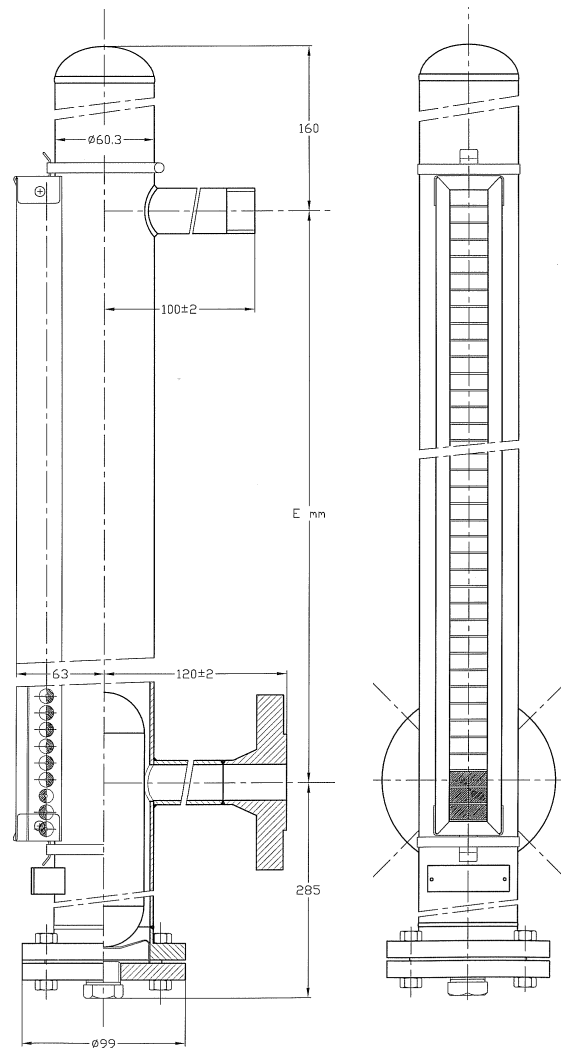

# Magnetic level gauge

**Data Sheet**  
DS-MLG-810-eng  
June, 2008

## Type 810 Standard designs

### Metallic Versions High dirty 304L-316L Stainless Steel code C20...

Chamber	Material: St. St. 316L Ø 60,3mm x 2,77 mm Ø 73,03mm x 5,16 mm Ø 73,03mm x 7,1 mm Others on request
TOP	Welded caps 316L + Vent + Plug ½" NPT Option – see page 29
BOTTOM	Drain + plug ½" NPT Full Flanges Type 11B1 WN FS From PN20 (150#) to PN420(2500#) Option – see page 29
Connections	Side-side connections ISO/ ANSI Flanges PN 20(150#) to 420(2500#) RF and RTJ ½ Coupling SW 3000 ½ Coupling BSPP-F ½ Coupling NPT-F 3000 Tube 316L BSPP-M Tube 316L NPT-M See for connections specifications pages 12 -25
C- to- C dimension	Minimum: E= 300 mm Maximum: E= 5500 mm Longer dimensions on request (Instrument supplied with sections)
Floats	St. St. 316L Titanium tube Machined Titanium Interface See for floats specifications pages 30 - 35
Reading system	R - Polyamid Rollers (PA6V) red / white VA – Aluminium red / white Wafers S – Slider Visual test of damaged float See for reading systems specifications pages 8 -10
Alarm Contacts	See for contacts specifications pages 40-41
Transmitteur	See for transmitter specifications page 36 - 39
Reading scales	St. St. 316L or aluminium Silk printed See for reading scales options page 10

Process conditions	
Temperature	From -160°C to + 350°C
Pressure	From -1 Atm to 240 bars
S. gravity	From 0,4 kg/m³ Others on request

PED 97/23/EC	Max CAT IV
--------------	------------

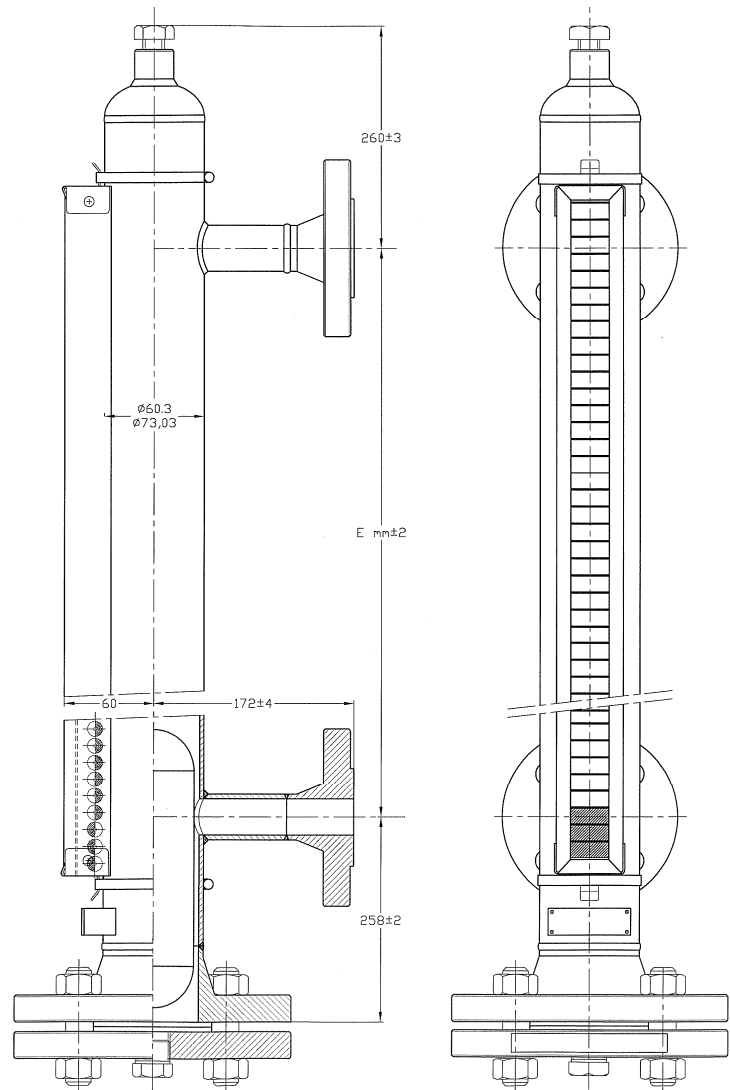



**Type 810**  
**Standard designs**

**Plastic Versions**  
**U-PVC / PPH / PVDF**

<b>Chamber</b>	Material: U-PVC/ PVDF/ PPH $\varnothing$ 63mm x 4,7mm U-PVC $\varnothing$ 63mm x 3,6mm PPH $\varnothing$ 63mm x 3mm PVDF Top mounted version available on request Others on request
<b>TOP</b>	Welded caps Option – see page 29
<b>BOTTOM</b>	Drain + 1/2" BSPP plug Option – see page 29
<b>Connection</b>	Side – Side connection ISO/ ANSI flange from PN 16 to 20 ND25 Loose flange / tube  See for connection details pages 12 to 25 Others on request
<b>C- to- C dimension</b>	Minimum: E= 300 mm Maximum: E= 5500 mm
<b>Floats</b>	U-PVC PPH PVDF Others on request See for floats specifications pages 30 - 35
<b>Reading system</b>	R - Polyamid Rollers (PA6V) red / white VA – Aluminium red / white Wafers S – Slider Visual test of damaged float See for reading systems specifications pages 8 -10
<b>Alarm Contacts</b>	See for contacts specifications pages 40-41
<b>Transmitter</b>	See for transmitter specifications page 36 - 39
<b>Reading scale</b>	St.St. 316L or aluminium Silk printed See for reading scales options page 10
<b>Process conditions</b>	
<b>Temperature</b>	U-PVC: 60°C max PPH: 80°C max PVDF: 130°C max
<b>Pressure</b>	10 bars max. (6bars with gases from Group 1)
<b>S. gravity</b>	From 0,9 kg/m <sup>3</sup> Others on request
<b>PED 97/23/EC</b>	Art. 3. 3 only – Non CE approved

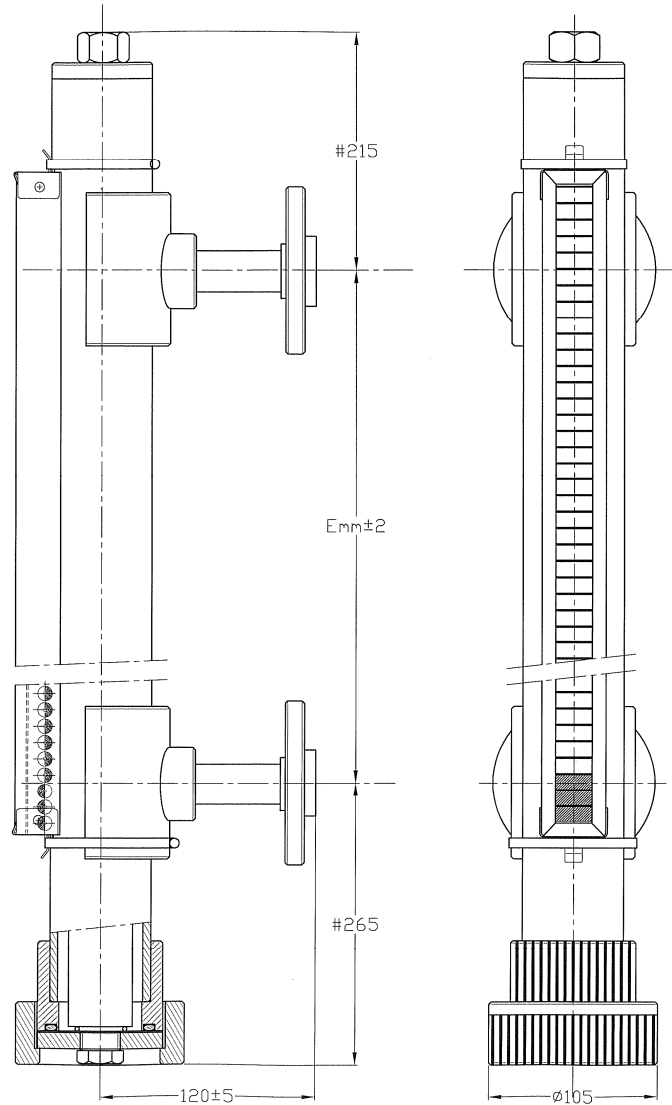

# Magnetic level gauge

**Data Sheet**  
 DS-MLG-810-eng  
 June, 2008

## Type 810 Reading systems

### Bi-coloured Rollers indicator

**Coding R**

<b>Housing</b>	Thickness: 1mm Material: 316L Stainless steel Gaskets: Silicone IP: 65
<b>Rollers</b>	Size: Ø9mm x 21mm Material: polyamid (PA6V – 30%) Stops to prevent rollers to rotate 360° Continuous visual indication Magnet: Ticonal (360°) Colours: red/ white/ blue
<b>Screen</b>	Material: transparent Polycarbonate
<b>Process Temperature</b>	From - 20°C to +120°C as standard Up to +200°C with insulation option
<b>Accuracy</b>	10mm
<b>Float test</b>	Visual test of damaged float by colour indication (three last rollers turn blue in case of problem)

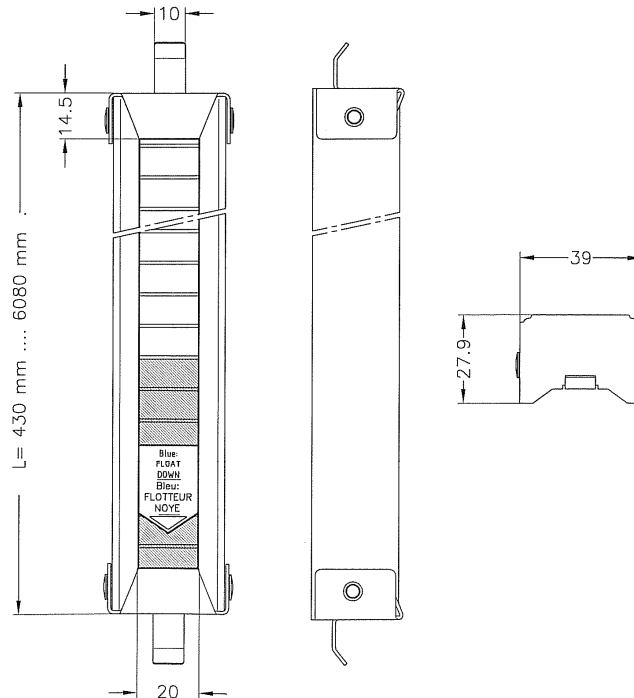

### Bi-coloured wafers (high temp. processes)

**Coding VA**

<b>Housing</b>	Thickness: 1mm Material: 316L Stainless steel Gaskets: Silicone IP: 65
<b>Flaps/ wafers</b>	Size: 9mm x 21mm Material: Aluminium Magnet: Ticonal (360°) Colours: red/ white/ blue
<b>Screen</b>	Material: Glass "Vetroceramique" 4mm thick
<b>Process Temperature</b>	Up to + 400°C
<b>Accuracy</b>	10mm
<b>Float test</b>	Visual test of damaged float by colour indication (three last rollers turn blue in case of problem)

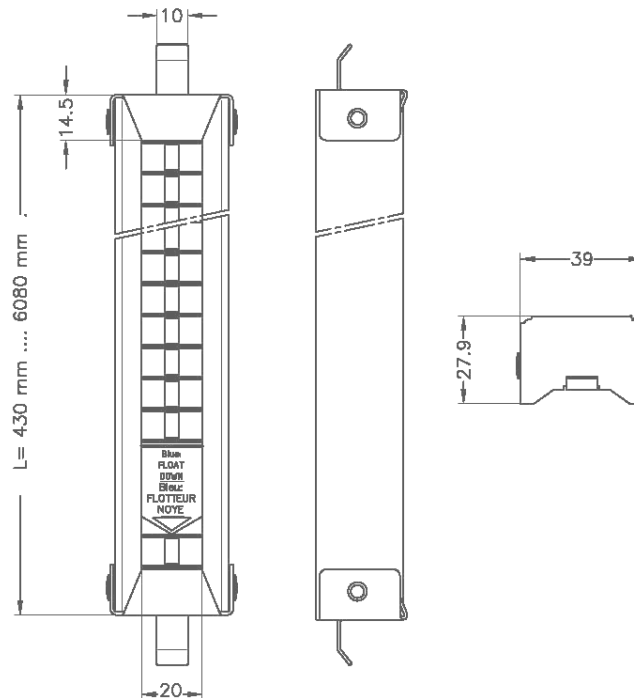

## Type 810 Reading systems

### Bi-coloured wafers (low temp. processes)

**Coding** VA + Z22

<b>Housing</b>	Thickness: 1mm Material: 316L Stainless steel Gaskets: Silicone IP: 65
<b>Flaps/ wafers</b>	Size: 9mm x 21mm Material: Aluminium Magnet: Ticonal (360°) Colours: red/ white/ blue
<b>Screen</b>	Polycarbonate block

<b>Process Temperature</b>	-20 to - 160°C
<b>Accuracy</b>	10mm
<b>Float test</b>	Visual test of damaged float by colour indication (three last rollers turn blue in case of problem)

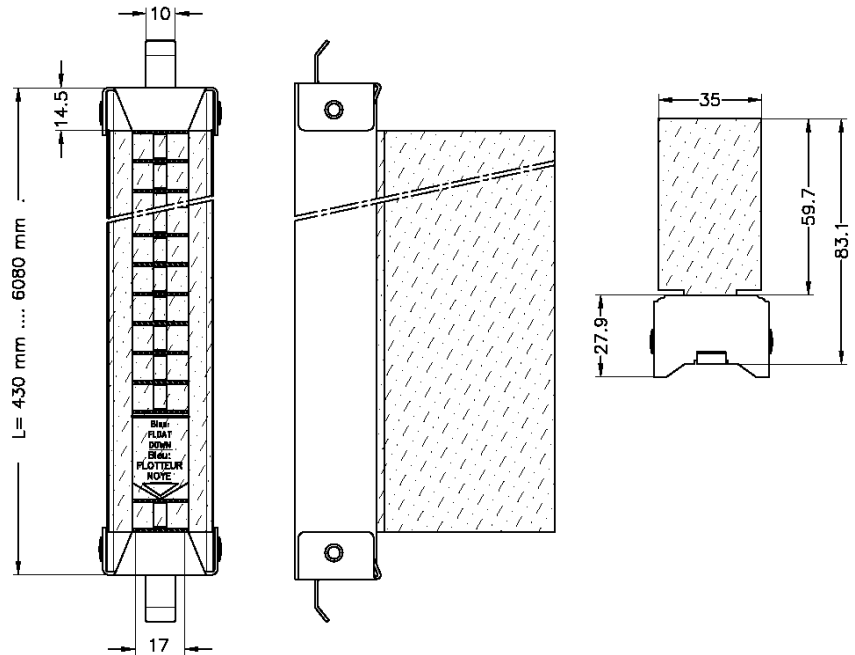

### Magnetic Slider

**Coding** S

<b>Glass Tube</b>	Material: Glass "PYREX" Ø24 Plugs on both sides IP: 66
<b>Slider</b>	Size: 9mm x 21mm Material: Aluminium Magnet: Samarium cobalt Colour: fluorescent Red
<b>Graduated scales</b>	Material: aluminium/ 316L St. St. Scales: Silk printed (see page 10) Units: Cm as standard

<b>Process Temperature</b>	Up to + 400°C
<b>Accuracy</b>	5 mm

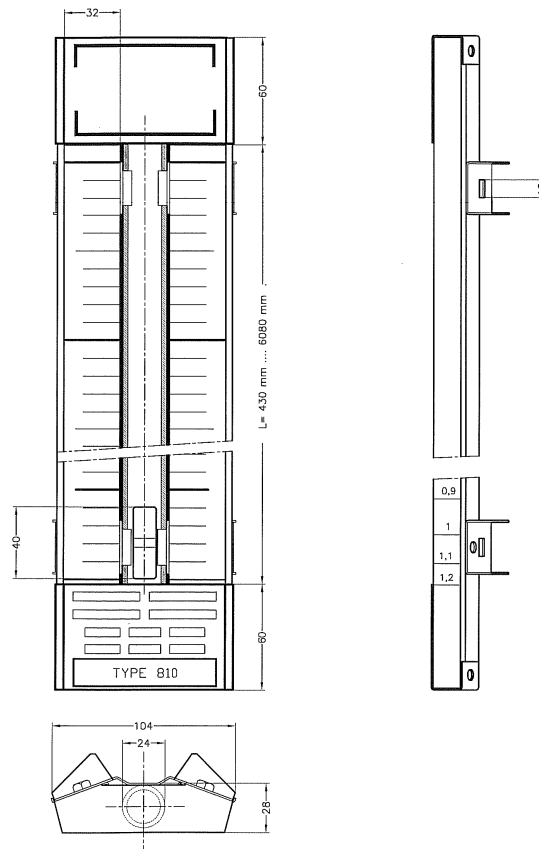

# Magnetic level gauge

## Type 810 Reading systems – Options and accessories

### Anti-frost window Coding Z22

Screen Material: transparent Polycarbonate block  
Suitability Use on type "VA" models only  
Temperatures -20 to -160°C

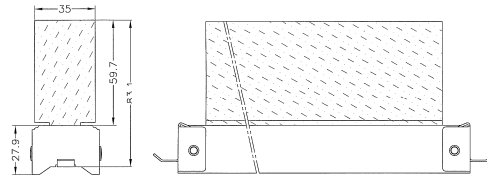

### Thermal shield for indicators and/or transmitters Coding Z2

Screen Material: Glass fiber  
Temperatures from 120°C on type "R" models  
from 150°C for transmitters  
from 200°C on type "VA" models

### Graduated scales / Metallic scales

Coding	Z24/i	Z23/i	Z12 or Z12/i	Z11 or Z11/i
--------	-------	-------	--------------	--------------

Indicator	R / VA	R / VA	S	S
Units	Graduations Cm , figures each dm	Customized	Graduations Cm , figures each dm	Customized
Material	316L St. St.	316L St. St.	Aluminium or 316L St. St.	Aluminium or 316L St. St.
Mounting	Point Welded	Point Welded	Part of the indicator frame	Part of the indicator frame
Dimensions	Square: 20mmx30mmx1,5mm	Square: 20mmx30mmx1,5mm	Width: 32mm	Width: 32mm

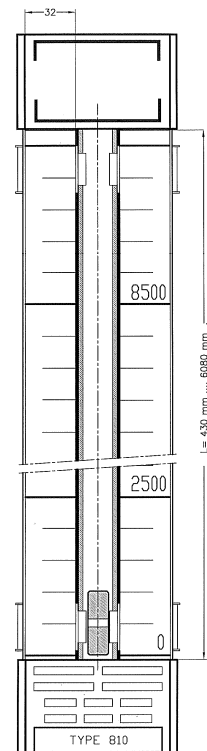
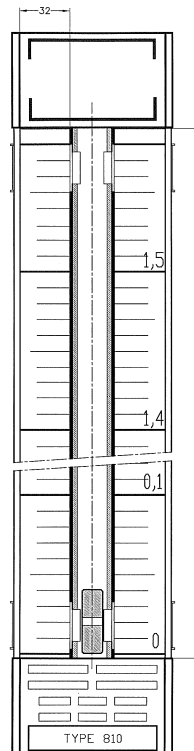
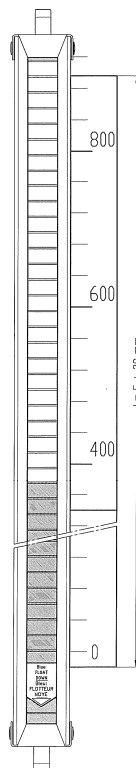
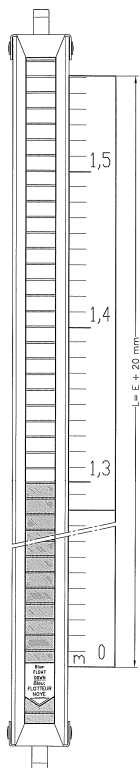
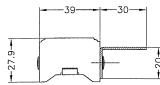
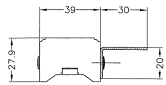

*This page intentionally blank*

# Magnetic level gauge

## Type 810 Process connection PN 16

304L Stainless steel

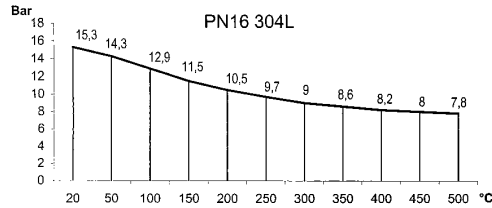

### CODE

	C2	C6	C8	C8/1	C8/2	C9	C9/1	C9/2
	Full loose flange Carbon steel St.St. Collar	Full Flange Welding neck RF R <sub>s</sub> =3,2-6,3	Drilled blind flange RF + 1" Tube R <sub>s</sub> =3,2-6,3	1/2 Coupling SW 3000	1/2 Coupling BSPP- F NPT- F	St. St. Tube BW	St. St. Tube BSPP Male	St. St. Tube NPT Male
	P <sub>max</sub> = 11 bar @ 20°C			P <sub>max</sub> = 15,9 bar @ 20°C				
	DN 20 and 25 ANSI 3/4" and 1"		DN 32-40-50 ANSI 1 1/4 1" 1/2 - 2"	DN 20 and 25 ANSI 3/4" and 1"				
	P=130mm (DN20-25) / P=120mm (DN32) P=135mm(DN40) / P=165mm (DN50)			ØT= 26,9mm / DN20 ØT= 33,7mm / DN25 th=2mm		ØT= 26,6mm th = 3,91mm / DN20 ØT= 33,7mm th = 3,27mm / DN25	ØT= 26,9mm th = 3,91mm / DN20 ØT= 33,7mm th = 3,27mm / DN25	
				P= 64 mm / DN20 P= 67 mm / DN25		P= 120mm	P= 120mm	
	PED 97/23/CE : Liquids and gases from Group 2 Only – Category I max (Ps.V=200)							
	Type "D100" Flange Drain + 1/2"NPT plug "Klingersil C4430" gasket 304L Stainless steel bolting							
	See page 29 for vent and drain options							
	Z 14 : 316L St. St. Bolting							

## Type 810 Process connection PN 16

**316L Stainless steel**

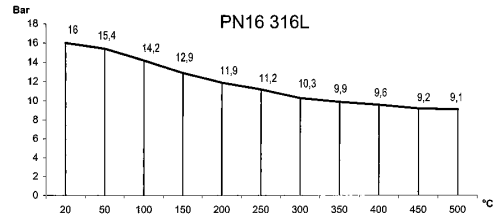

### CODE

	C12	C16	C18	C18/1	C18/2	C19	C19/1	C19/2
	Full loose flange	Full Flange	Drilled blind flange	½ Coupling	½ Coupling	St. St. Tube	St. St. Tube	St. St. Tube
	Carbon steel	Welding neck	RF + 1" Tube	SW 3000	BSPP- F	BW	BSPP Male	NPT Male
	St.St. Collar	RF			NPT- F 3000			
		R <sub>a</sub> =3,2-6,3	R <sub>a</sub> =3,2-6,3					
	Pmax= 13 bar @ 20°C			Pmax = 15,9 bar @ 20°C				
	DN 20 and 25 ANSI ¾" and 1"			DN 32-40-50 ANSI 1" 1½ - 2"				
				P= 64 mm / DN20 P= 67 mm / DN25		P= 120 mm		P= 120 mm
	P=130 mm (DN20-25) /P=120mm(DN32) P=135mm(DN40)/ P=165mm (DN50)			ØT= 26.9mm / DN20 ØT= 33.7mm / DN25		ØT= 26.6mm th= 3.91mm / DN20 ØT= 33.7mm th = 3.27mm/ DN25		ØT= 26.6 mm th = 3.91 mm / DN20 ØT= 33.7 mm th = 3.2 mm / DN25
	PED 97/23/CE : Liquids and gases from Group 2 Only – Category I max (Ps.V=200)							
	Type "D100" Flange Drain + ½"NPT plug "Klingsil C4430" gasket 304L Stainless steel bolting							
	See page 29 for vent and drain options							
	<b>Z 14</b> : 316L St. St. Bolting <b>Z 9</b> : Full penetration welds							

# Magnetic level gauge

**Data Sheet**  
 DS-MLG-810-eng  
 June, 2008

Type 810  
 Process connection

## PN 20 (ANSI 150#)

304L Stainless steel

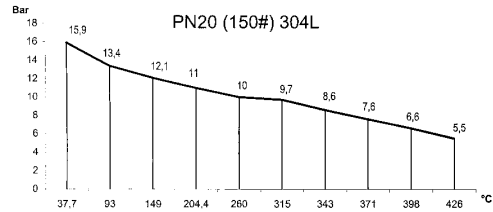

### CODE

C7		C4		C20	
Full Flange Welding neck RF	Drilled blind flange RF + 1" Tube	Full Flange Welding neck RF	Drilled blind flange RF + 1" Tube	Full Flange Welding neck RF	Full Flange WN RF + Reduction /DN25
R <sub>a</sub> =3,2-6,3 DN 20-25	R <sub>a</sub> =3,2-6,3 DN 32-40-50	R <sub>a</sub> =3,2-6,3 DN 20-25	R <sub>a</sub> =3,2-6,3 DN 32-40-50	R <sub>a</sub> =3,2-6,3 DN 20-25	R <sub>a</sub> =3,2-6,3 DN 32 - 40 - 50
ANSI ¾"-1"	ANSI 1"¼ - 1" ½ - 2"	ANSI ¾"-1"	ANSI 1"¼ - 1" ½ - 2"	ANSI ¾" - 1"	ANSI 1"¼ - 1" ½ - 2"
304L St.St. Chamber ØD = 60,3mm x 2mm welded				316L St.St. Chamber ØD = 60,3mm x 2,77 mm seamless	
Pmax= 15,9 bar @ 20°C					
A= 300mm (410mm with floats from M7 type)					
P=130mm (DN20-25) / P=120mm(DN32) / P=135mm(DN40) / P=165mm (DN50)					
PED 97/23/CE : Liquids and gases from Group 2 Only – Category I max. (Ps.V=200)		PED 97/23/CE : Category II max.		PED 97/23/CE : Category IV max.	
Type "D100" Flange + Drain + ½"NPT plug + "Klingsil C4430" gasket Full Flange 11B DN50 PN 20 WN RF R <sub>a</sub> =3,2-6,3 + Blind flange 05B PN20 RF					
Drain + ½"NPT plug "Klingsil C4430" gasket B72H Bolting (Carbon steel)					
See page 29 for vent and drain options					
Z 14 : 316L St. St. Bolting			Z 13 : 304L St. St. Bolting		



## Type 810 Process connection

# PN 20 (ANSI 150#)

316L Stainless steel

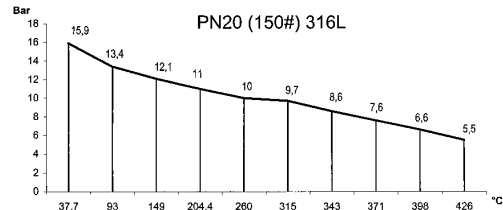

### CODE

Ø D	C 17		C 14		C 30		C 30/1	C 30/2	C 30/3	
	Full Flange WN - RF	Drilled blind flange RF + 1" Tube	Full Flange WN - RF	Drilled blind flange RF + 1" Tube	Full Flange WN - RF	Full Flange WN RF + Reduction /DN25	½ Coupling SW 3000	½ Coupling NPT- F 3000	St. St. Tube NPT Male	
	R <sub>s</sub> =3,2-6,3 DN 20-25 ANSI ¾" - 1	R <sub>s</sub> =3,2-6,3 DN 32-40-50 ANSI 1"¼	R <sub>s</sub> =3,2-6,3 DN 20-25 ANSI ¾" - 1	R <sub>s</sub> =3,2-6,3 DN 32-40-50 ANSI 1"¼	R <sub>s</sub> =3,2-6,3 DN 20-25 ANSI ¾" - 1"	R <sub>s</sub> =3,2-6,3 DN 32 - 40 - 50 ANSI 1"¼ - 1" ½ - 2"	DN 20-25 ANSI ¾" - 1	DN 20-25 ANSI ¾" - 1	DN 20-25 ANSI ¾" - 1	
	P <sub>max</sub> = 15,9 bar @ 20°C									
	316L St.St. Chamber ØD = 60,3mm x 2mm welded					316L St.St. Chamber ØD = 60,3mm x 2,77 mm seamless				
	A = 300mm (410mm with floats from M7 type) P(mm) P=130 mm (DN20-25) / P=120mm(DN32) / P=135mm(DN40) / P=165mm (DN50)									
	PED 97/23/CE : Liquids and gases from Group 2 Only – Category I max. (Ps.V=200)		PED 97/23/CE: Category II max. (no instable gas)		PED 97/23/CE : Category IV max.					
A (mm)	<p>Type "D100" flange Stainless steel bolting</p> <p>Drain+ ½"NPT plug + "Klingsil C4430" gasket</p> <p>Full flange 11B DN50 PN20 WN RF R<sub>s</sub>=3,2-6,3 + Blind flange 05B PN20 RF</p> <p>Drain+ ½"NPT plug "Klingsil C4430" gasket B72H Bolting (Carbon steel)</p> <p>See page 29 for vent and drain options</p>									
	Z 14 : 316L St. St. Bolting / Z 13 : 304L St. St. Bolting									
	Z 9 : Full penetration welds									

# Magnetic level gauge

## Type 810 Process connection PN 40

304L Stainless steel

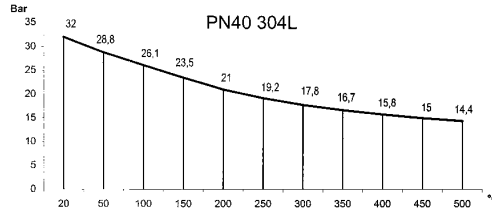

### CODE

**C 3**

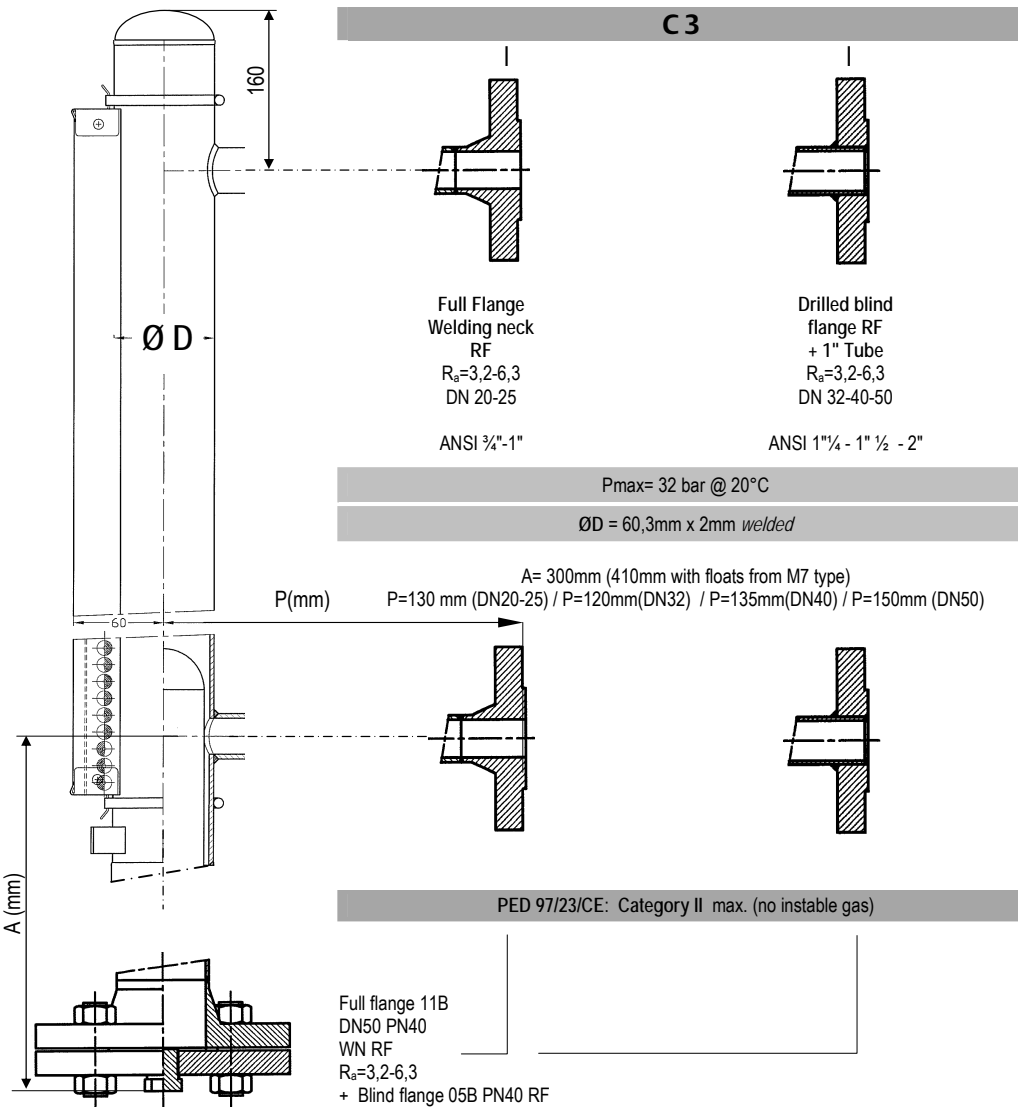

Pmax= 32 bar @ 20°C

ØD = 60,3mm x 2mm welded

PED 97/23/CE: Category II max. (no instable gas)

Full flange 11B  
DN50 PN40  
WN RF  
Ra=3,2-6,3  
+ Blind flange 05B PN40 RF

Drain + 1/2"NPT plug  
"Klingersil C4430" gasket  
B72H Bolting (Carbon steel)

See page 29 for vent and drain options

**Z 13** : 304L St. St. Bolting

Type 810  
 Process connection  
**PN 40**

**316L Stainless steel**

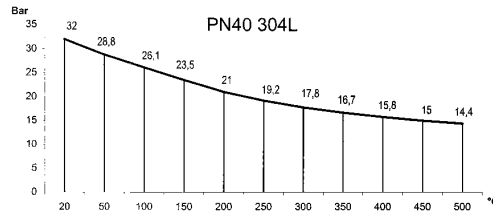

**CODE**

**C 13**

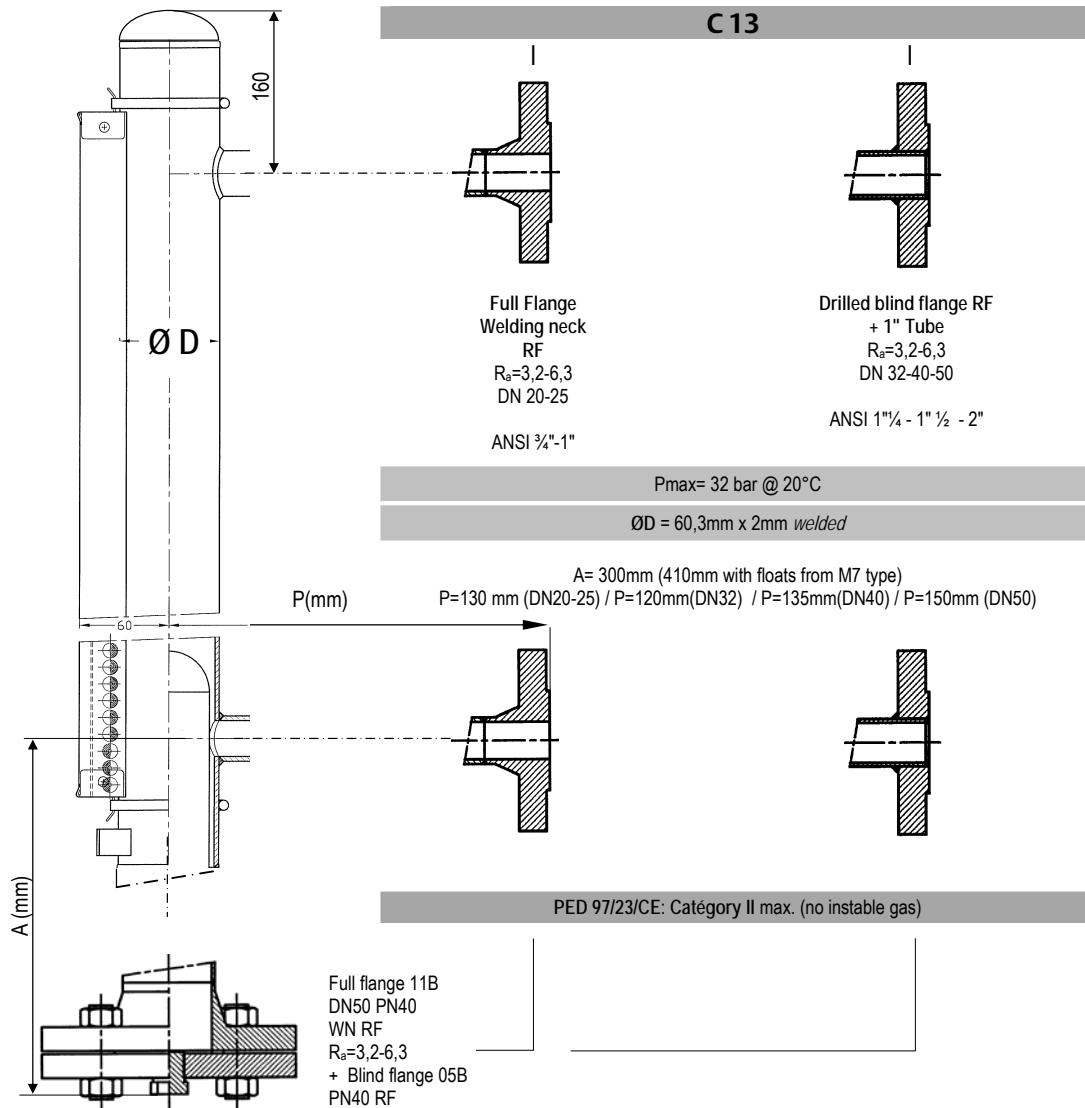

$P_{max}= 32 \text{ bar @ } 20^\circ\text{C}$

$\text{ØD} = 60,3\text{mm} \times 2\text{mm welded}$

A= 300mm (410mm with floats from M7 type)

P=130 mm (DN20-25) / P=120mm(DN32) / P=135mm(DN40) / P=150mm (DN50)

PED 97/23/CE: Category II max. (no instable gas)

Drain +  $\frac{1}{2}$ "NPT plug  
 "Klingsil C4430" gasket  
 B72H Bolting (Carbon steel)

See page 29 for vent and drain options

**Z 13** : 304L St. St. Bolting / **Z 14** : 316L St. St. Bolting

**Z 9** : Full penetration welds

# Magnetic level gauge

Type 810  
Process connection

## PN 50 (ANSI 300#)

### 304L Stainless steel

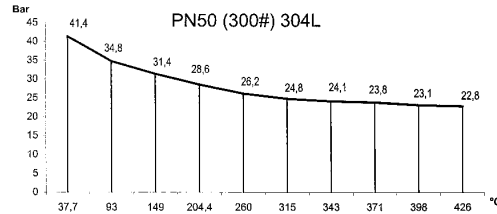

Vent + 1/2" NPT plug (option for C5)

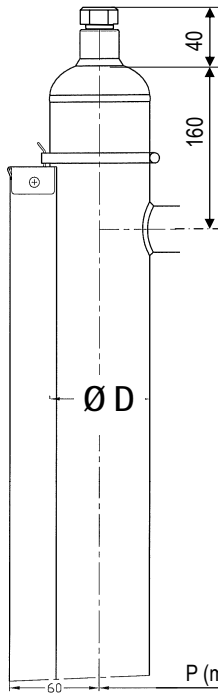

#### CODE

C5		C21		C26	
Full Flange WN RF R <sub>a</sub> =3,2-6,3 DN 20 - 25 ANSI 3/4" - 1"	Full Flange WN RF + Reduction /DN25 R <sub>a</sub> =3,2-6,3 DN 32 - 40 - 50 ANSI 1 1/4" - 1 1/2" - 2"	Full Flange WN RF R <sub>a</sub> =3,2-6,3 DN 20 - 25 ANSI 3/4" - 1"	Full Flange WN RF + Reduction /DN25 R <sub>a</sub> =3,2-6,3 DN 32 - 40 - 50 ANSI 1 1/4" - 1 1/2" - 2"	Full Flange WN RF R <sub>a</sub> =3,2-6,3 DN 20 - 25 ANSI 3/4" - 1"	Full Flange WN RF + Reduction /DN25 R <sub>a</sub> =3,2-6,3 DN 32 - 40 - 50 ANSI 1 1/4" - 1 1/2" - 2"
Pmax = 32 bars @ 20°C		Pmax = 40 bars @ 20°C		Pmax = 40 bars @ 20°C	
304L St.St. Chamber ØD= 60,3mm th= 2mm welded		316L St.St. Chamber ØD= 60,3mm th= 2,77 mm seamless		316L St.St. Chamber ØD= 73,03mm th= 5,16 mm	
PED 97/23/CE: Category II max. (no instable gas)		PED 97/23/CE : Category IV max.			

A= 300mm (410mm with floats from M7 type)  
P= 140 mm(DN20); 150mm(DN25); 140mm(DN32); 155mm(DN40); 170 (DN50)  
A(mm) see below  
P= 160 mm(DN20-DN25); 170mm(DN32); 180mm(DN40-DN50)

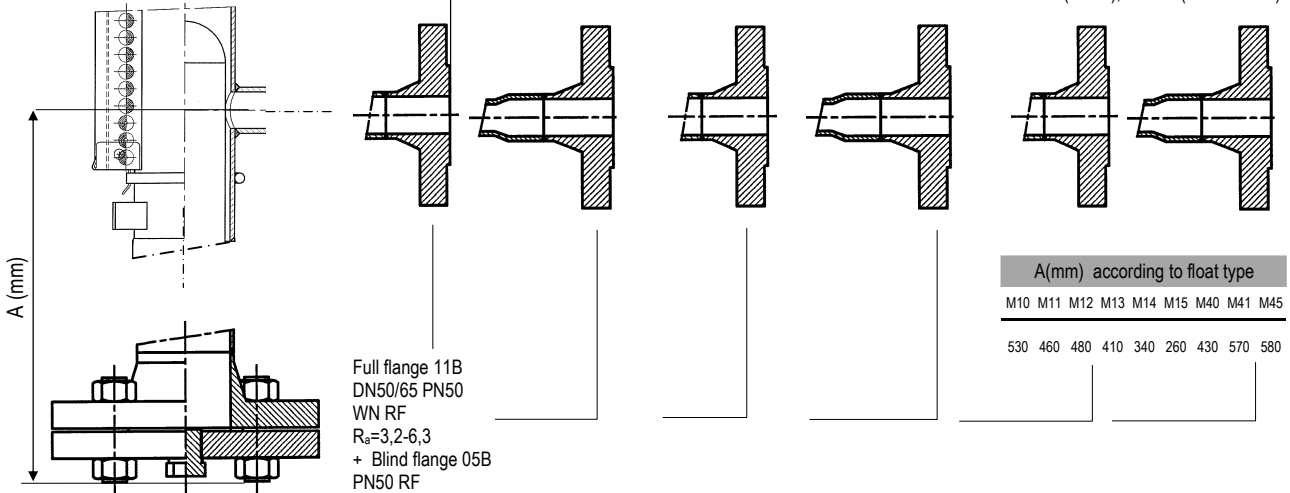

A(mm) according to float type							
M10	M11	M12	M13	M14	M15	M40	M45
530	460	480	410	340	260	430	570

Drain + 1/2" NPT plug  
Gasket  
B72H Bolting (Carbon steel)

See page 29 for vent and drain options

"Klingsil C4430" as std	Spiralé inox 316/Graphite asstd
Z 28 : Spiral Wounded 316/Graphite	
Z 13 : 304L St. St. Bolting	Z 14 : 316L St. St. Bolting / Z 13 : 304L St. St. Bolting



# Magnetic level gauge

Type 810  
Process connection

**PN 100 (ANSI 600#)**

**304L Stainless steel**

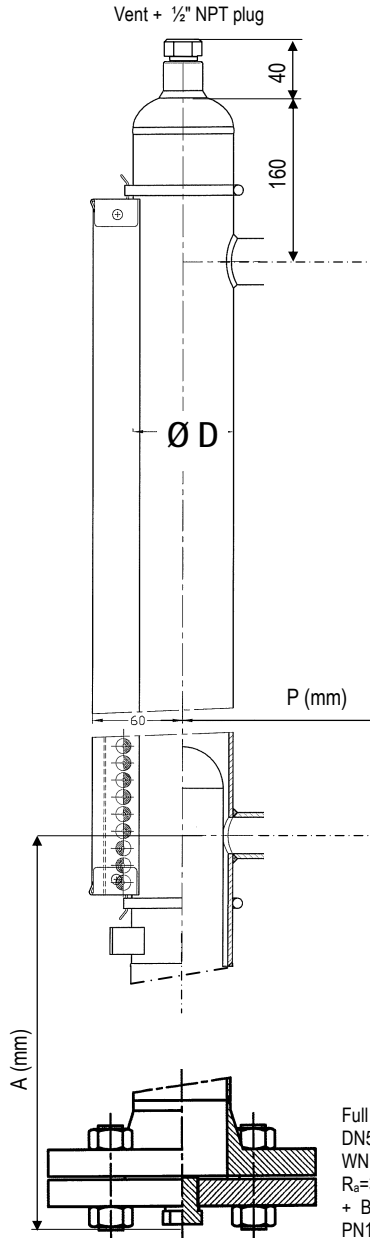
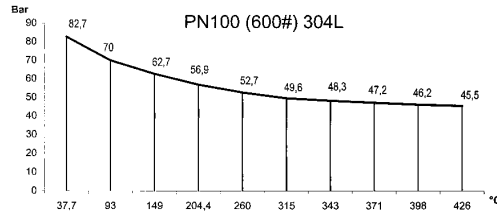

CODE			
C 22		C 23	
Full Flange WN RF R <sub>a</sub> =3,2-6,3 DN 20 - 25 ANSI 3/4" - 1"	Full Flange WN RF + Reduction R <sub>a</sub> =3,2-6,3 DN 32 - 40 - 50 ANSI 1 1/4" - 1 1/2" - 2"	Full Flange WN RF R <sub>a</sub> =3,2-6,3 DN 20 - 25 ANSI 3/4" - 1"	Full Flange WN RF + Reduction /DN25 R <sub>a</sub> =3,2-6,3 DN 32 - 40 - 50 ANSI 1 1/4" - 1 1/2" - 2"
Pmax = 78 bars @ 20°C		Pmax = 80 bars @ 20°C	
316L St.St. Chamber ØD= 60,3mm th= 2,77 mm		316L St.St. Chamber ØD= 73,03mm th= 5,16 mm	
A= 310mm (410mm with floats from M7 type)		A(mm) see below	
P=150mm (DN20); 160mm (DN25) 150mm(DN32); 165mm(DN40); 180mm (DN50)		P=160mm (DN20); 170mm (DN25) 170mm(DN32); 180mm(DN40); 180mm (DN50)	
PED 97/23/CE : Category IV max.			

A(mm) according to float type									
M10	M11	M12	M13	M14	M15	M40	M41	M45	
530	460	480	410	340	260	430	570	580	

Full flange 11B  
DN50/65 PN100  
WN RF  
R<sub>a</sub>=3,2-6,3  
+ Blind flange 05B  
PN100 RF

Drain + 1/2"NPT plug  
Gasket -----  
B72H Bolting (Carbon steel)

See page 29 for vent and drain options  
"Klingsil C4430" as std  
Spiral Wound. 316/Graphite as std  
**Z 14 : 316L St. St. Bolting**

**Type 810**  
**Process connection**

## PN 100 (ANSI 600#)

### 316L Stainless steel

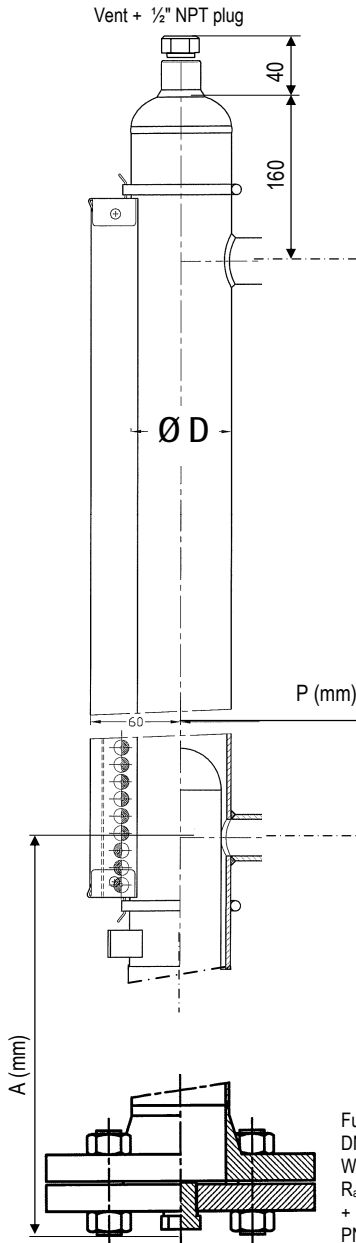
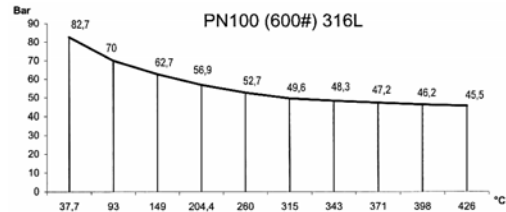

**CODE**

C 32		C 33	
Full Flange WN RF Ra=3,2-6,3	Full Flange WN RF + Reduction /DN25 Ra=3,2-6,3	Full Flange WN RF Ra=3,2-6,3	Full Flange WN RF + Reduction /DN25 Ra=3,2-6,3
DN 20 - 25 ANSI 3/4" - 1"	DN 32 - 40 - 50 ANSI 1 1/4" - 1 1/2" - 2"	DN 20 - 25 ANSI 3/4" - 1"	DN 32 - 40 - 50 ANSI 1 1/4" - 1 1/2" - 2"
Pmax = 78 bars @ 20°C		Pmax = 80 bars @ 20°C	
316L St.St. Chamber ØD= 60,3mm th= 2,77 mm seamless		316L St.St. Chamber ØD= 73,03mm th= 5,16 mm	
A= 310mm (410mm with floats from M7 type) P=150 mm (DN20); 160mm (DN25); 150mm(DN32); 165mm(DN40); 180mm (DN50)		A(mm) see below P=160 mm (DN20); 170mm (DN25) 170mm(DN32); 180mm(DN40); 180mm (DN50)	
PED 97/23/CE : Category IV max.			

A(mm) according to float type								
M10	M11	M12	M13	M14	M15	M40	M41	M45
530	460	480	410	340	260	430	570	580

Drain + 1/2"NPT plug  
 Gasket -----  
 B72H Bolting (Carbon steel)

See page 29 for vent and drain options  
 "Klingsil C4430" as std  
 Spiral Wounded. 316/Graphite as std  
**Z 14 : 316L St. St. Bolting**

# Magnetic level gauge

**Data Sheet**  
DS-MLG-810-eng  
June, 2008

Type 810  
Process connection

**PN 250 (ANSI 1500#)**

**304L Stainless steel**

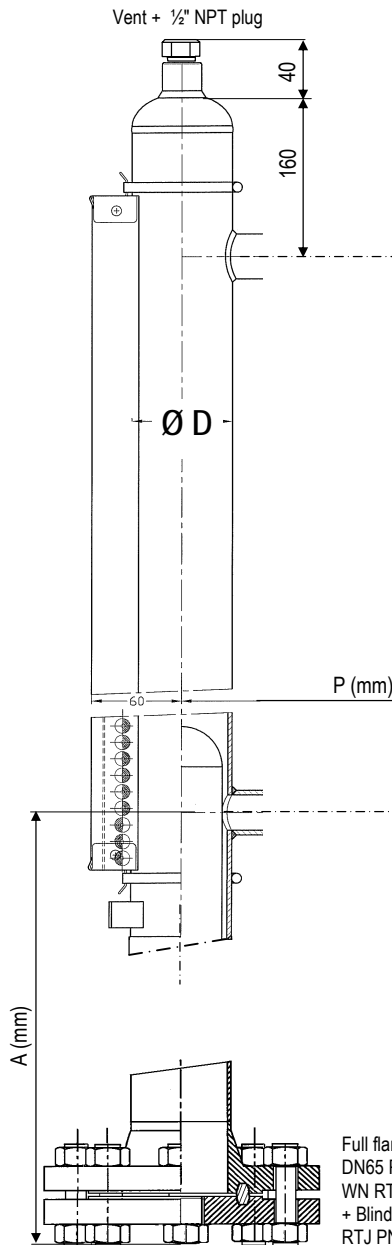
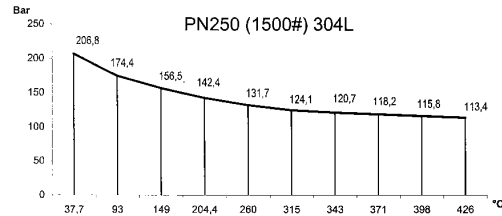

CODE

**C 24**

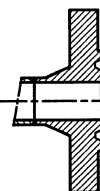

Full Flange  
WN RTJ

DN 20 - 25  
ANSI 3/4" - 1"

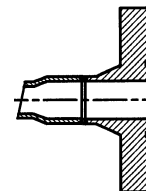

Full Flange  
WN RTJ  
+ Reduction /DN25

DN 32 - 40 - 50  
ANSI 1 1/4" - 1 1/2" - 2"

Pmax = 200 bars @ 20°C

316L St.St. Chamber ØD= 73,03mm th= 7,1 mm

A(mm) see below

P=180 mm (DN20), P=190mm (DN25)

P=190mm (DN32), P=190mm (DN40), P=210mm (DN50)

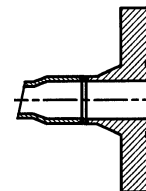
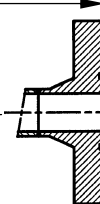

PED 97/23/CE : Category IV max.

A(mm) according to float type

M10	M11	M12	M13	M14	M15	M20	M21	M22	M23
550	480	500	430	360	310	500	430	360	270

Full flange 11J  
DN65 PN250  
WN RTJ  
+ Blind flange 05J  
RTJ PN250

Drain + 1/2"NPT plug  
St.St. 304 RTJ O ring  
B72H Bolting (Carbon steel)

See page 29 for vent and drain options

**Z 15** : St.St. 316 RTJ O ring

**Z 14** : 316L St. St. Bolting



**Type 810**  
**Process connection**

## PN 250 (ANSI 1500#)

**316L Stainless steel**

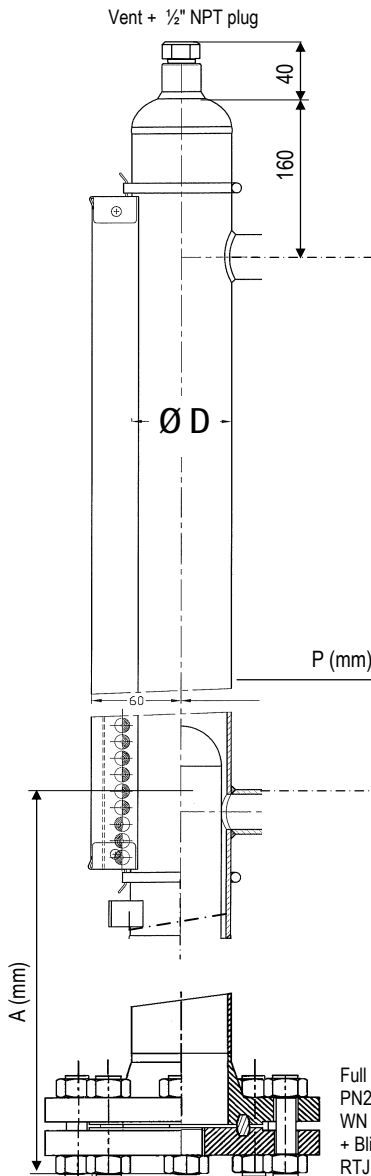
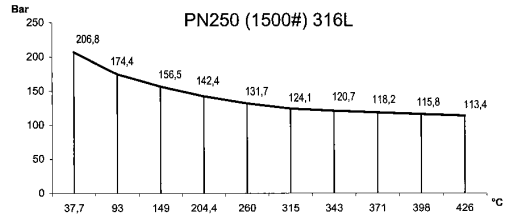

**CODE**

**C 34**

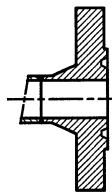

Full Flange  
WN RTJ

DN 20 - 25  
ANSI 3/4" - 1"

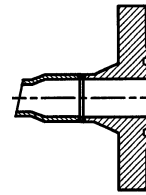

Full Flange  
WN RTJ  
+ Reduction /DN25

DN 32 - 40 - 50  
ANSI 1 1/4" - 1" 1/2" - 2"

Pmax = 200 bars @ 20°C

316L St.St. Chamber  
ØD= 73,03mm th= 7,1 mm

A(mm) see below

P=180mm (DN20), P=190mm (DN25)

P=190mm (DN32), P=190mm (DN40), P=210mm (DN50)

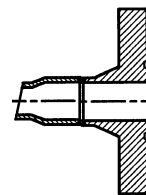
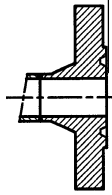

PED 97/23/CE : Category IV max.

A(mm) according to float type

M10	M11	M12	M13	M14	M15	M20	M21	M22	M23
550	480	500	430	360	310	500	430	360	270

Full flange 11J DN65  
PN250  
WN RTJ  
+ Blind flange 05J  
RTJ PN250

Drain + 1/2"NPT plug  
St.St. 304 RTJ O ring  
B72H Bolting (Carbon steel)

See page 29 for vent and drain options

**Z 15** : St.St. 316 RTJ O ring

**Z 14** : 316L St. St. Bolting

**Z 13** : 304L St. St. Bolting

# Magnetic level gauge

Type 810  
Process connection

**PN 420** (ANSI 2500#)

**304L Stainless steel**

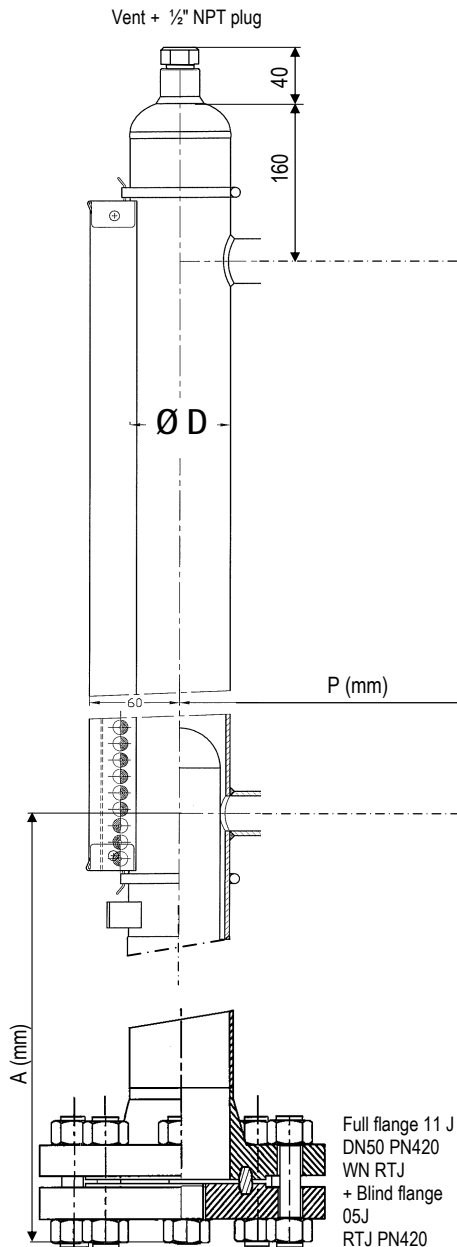
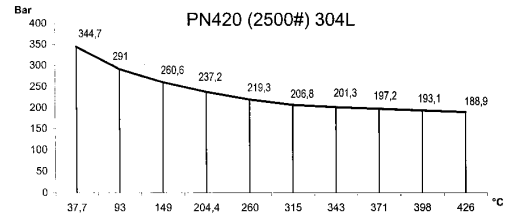

Drain + 1/2" NPT plug  
St.St. 304 RTJ O ring  
B72H Bolting (Carbon steel)

**CODE**

**C34**

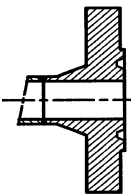

Full Flange  
WN RTJ

DN 20 - 25  
ANSI 3/4" - 1"

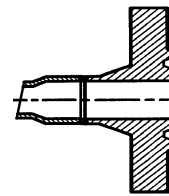

Full Flange  
WN RTJ  
+ Reduction /DN25

DN 32 - 40 - 50  
ANSI 1 1/4" - 1 1/2" - 2"

Pmax = 240 bars @ 20°C

316L St.St. Chamber ØD= 73,03mm th= 7,1 mm

A(mm) see below  
P=180mm (DN20), P=190mm (DN25)  
P=210mm (DN32), P=220mm (DN40), P=230mm (DN50)

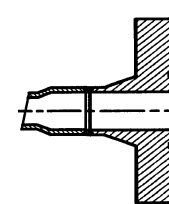
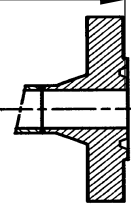

PED 97/23/CE : Category IV max.

A(mm) according to float type

M20	M21	M22	M23
520	450	380	330

Full flange 11 J  
DN50 PN420  
WN RTJ  
+ Blind flange  
05J  
RTJ PN420

See page 29 for vent and drain options

**Z 15** : St.St. 316 RTJ O ring

**Z 14** : 316L St. St. Bolting

**Z 13** : 304L St. St. Bolting

Type 810  
 Process connection

## PN 420 (ANSI 2500#)

304L Stainless steel

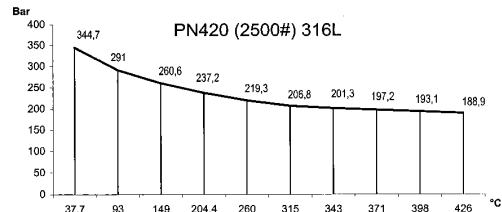

Vent + 1/2" NPT plug

40

160

Ø D

60

P (mm)

A (mm)

Drain + 1/2" NPT plug  
 St.St. 304 RTJ O ring  
 B72H Bolting (Carbon steel)

Full flange 11 J  
 DN65 PN420  
 WN RTJ  
 + Blind flange 05J  
 RTJ PN420

**CODE**

**C 35**

Full Flange  
WN RTJ

DN 20 - 25  
ANSI 3/4" - 1"

Full Flange  
WN RTJ  
+ Reduction /DN25

DN 32 - 40 - 50  
ANSI 1" 1/4 - 1" 1/2 - 2"

Pmax = 240 bars @ 20°C

316L St.St. Chamber ØD= 73,03mm th= 7,1 mm

A(mm) see below  
 P=180 mm (DN20) / P=190mm (DN25)  
 P=210mm (DN32) / P=220mm (DN40) / P=230mm (DN50)

PED 97/23/CE : Catégorie IV max.

A(mm) according to float type			
M20	M21	M22	M23
520	450	380	330

See page 29 for vent and drain options

**Z 15** : St.St. 316 RTJ O ring

**Z 14** : 316L St. St. Bolting

**Z 13** : 304L St. St. Bolting

# Magnetic level gauge

Type 810  
 Process Connection

## PN 16-20

U-PVC Version

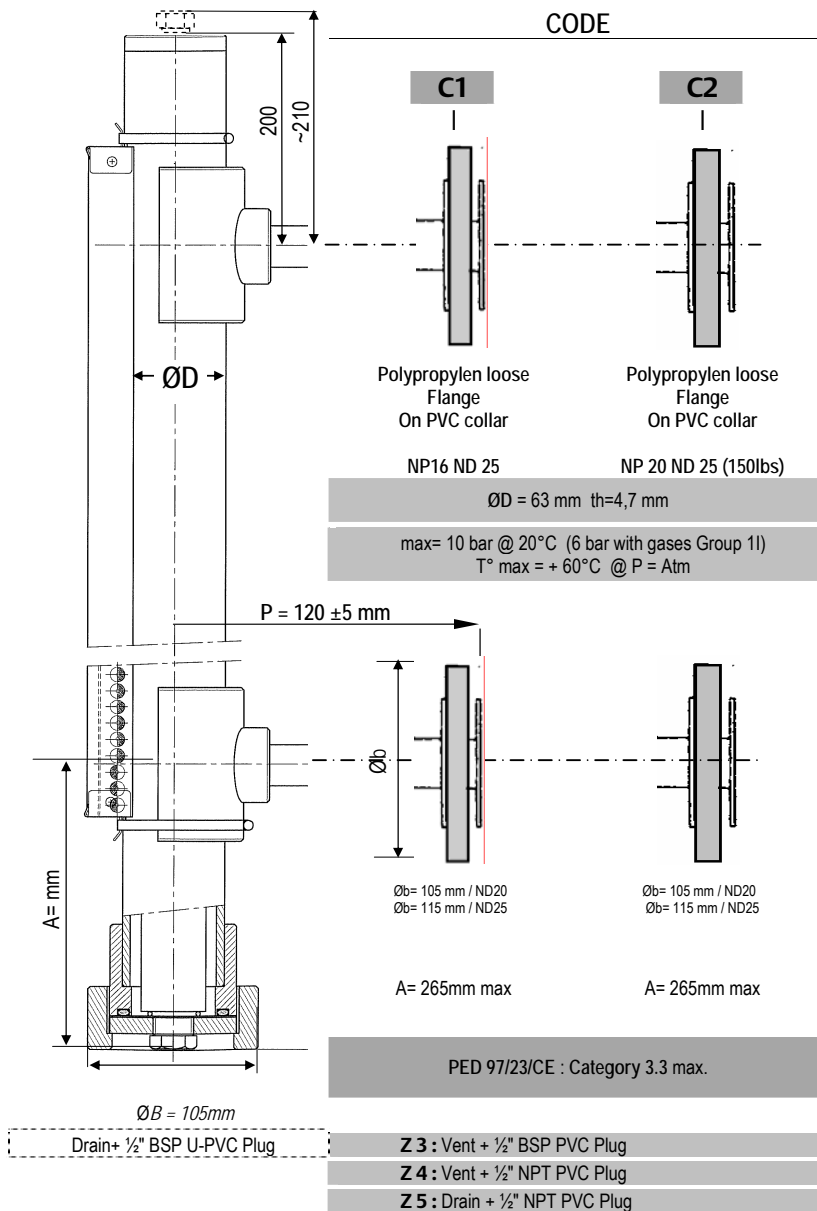

Type 810  
 Process Connection

NP 16-20

POLYPROPYLENE (PPH) Version

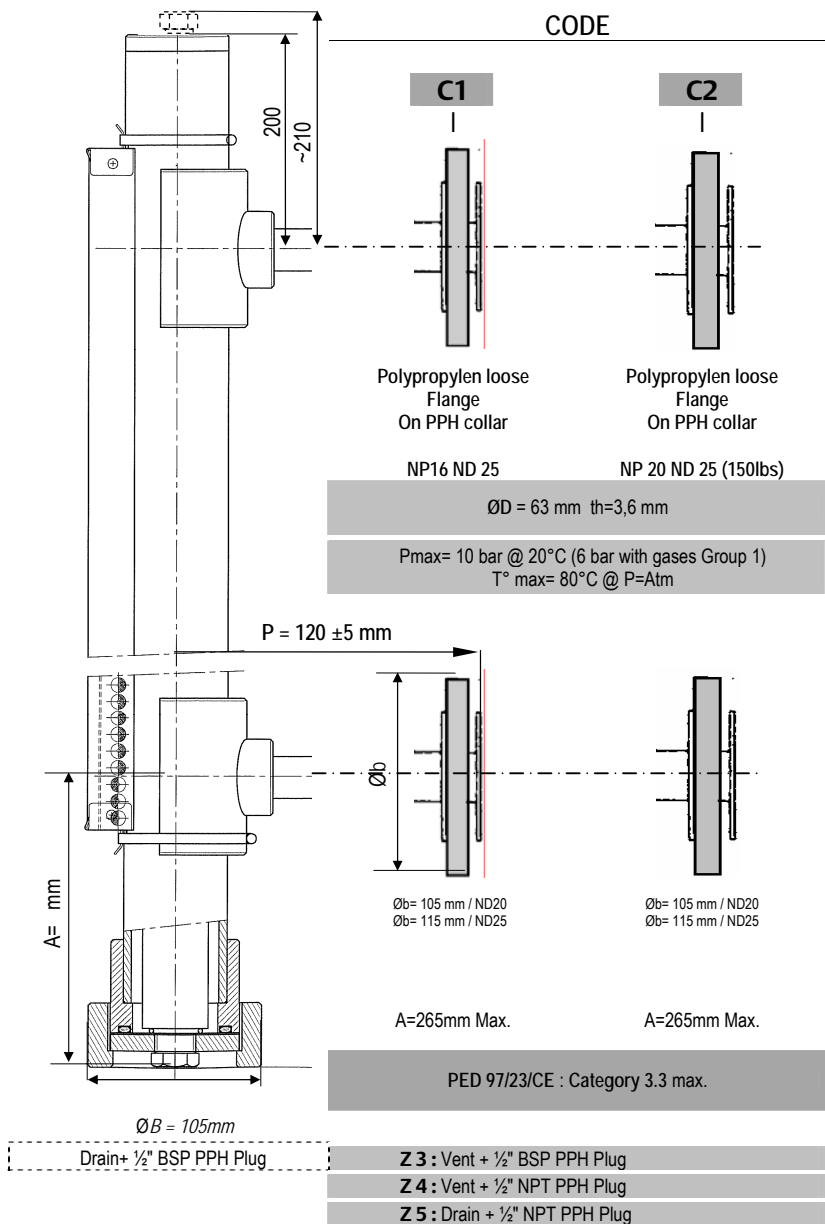

# Magnetic level gauge

Type 810  
 Process Connection

## NP 16-20

PVDF Version

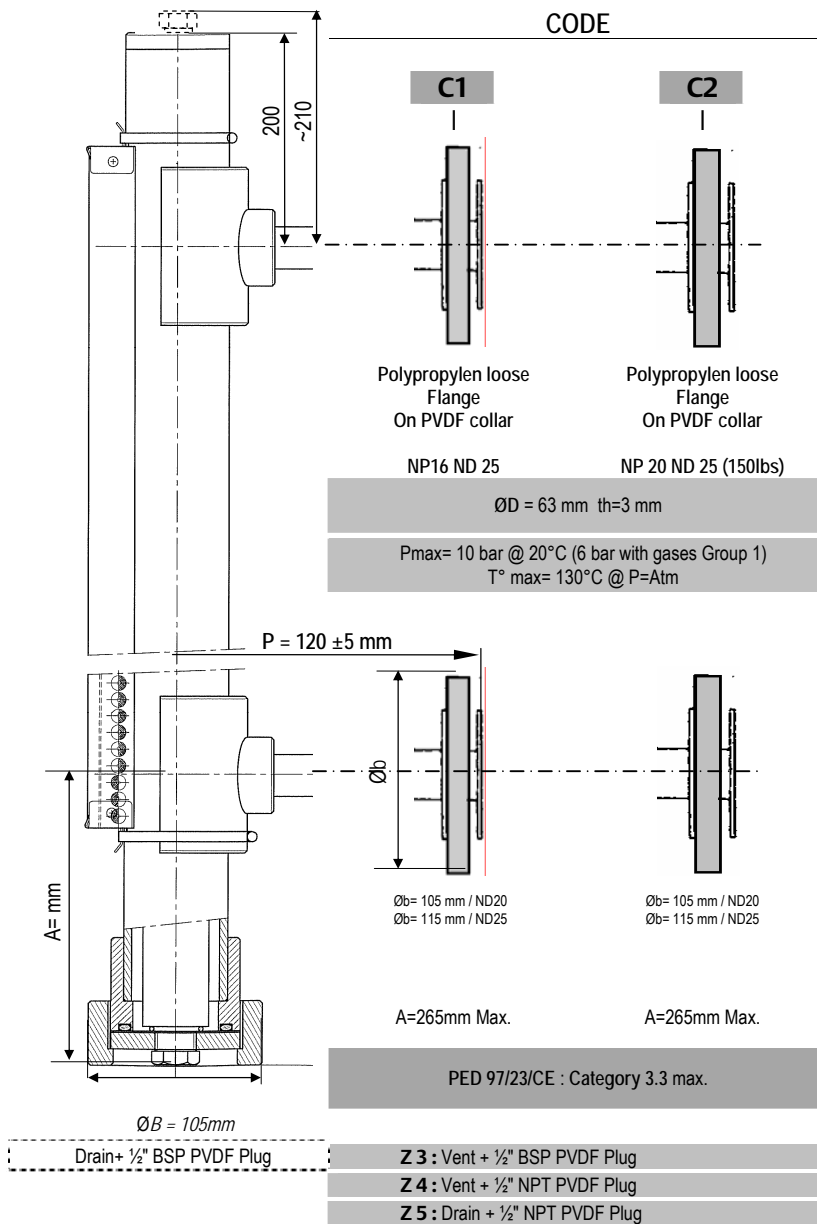

Type 810  
TOP and BOTTOM connections Options

**TOP Connections**  
Designations

	Vent Plug			WN RF Type 11 Flange	WN RF type 11 Flange + Blind type 05 Flange	WN RTJ Flange	WN RTJ Flange + Blind Flange	316 St.St. Valve	
	1/2" NPT	1/2" BSP	3/4" NPT					1/2" NPT-F	1/2" BSP-F
	NP Rating According to chamber rating								
Gasket	/	/	/	/	"Klingsil C4430" B8.8 St. St	St. St. spiral wounded B8.8 St. St	/	304 St. St. RTJ B8.8 St. St.	NP max 50 bar T 20°C Other on request
Bolting	Z 4	Z 3	Z 25		Z 66*		/		
ND 15	-	-	-	Z 33	Z 40	Z 58	Z 46	Z 52	
ND 20	-	-	-	Z 34	Z 41	Z 59	Z 47	Z 53	
ND 25	-	-	-	Z 35	Z 42	Z 60	Z 48	Z 54	Z 17/T Z 16/T
ND 50	-	-	-	Z 61	Z 63	Z 64	-	-	
ND 65	-	-	-	Z 62	-	Z 65	-	-	

\* Vent Flange type "100" identical to the bottom flange type

**BOTTOM connections**  
Designations

	Drain Plug 3/4" NPT	WN RF Type 11 Flange On pipe	WN RF Type 11 Flange On pipe + Blind RF type 05 Flange	WN RF RTJ Flange On pipe	Flange WN RTJ On pipe + Blind RTJ Flange	316 St.St. Valve	
						1/2" NPT-F	1/2" BSP-F
	NP Rating According to chamber rating						
Gasket	/	/	"Klingsil C4430" B8.8 St. St	St. St. spiral wounded B8.8 St. St	/	304 St. St. RTJ B8.8 St. St	NP max 50 bar T 20°C Other on request
Bolting	Z 26				/		
ND 15	-	Z 30	Z 37	Z 55	Z 43	Z 49	
ND 20	-	Z 31	Z 38	Z 56	Z 44	Z 50	Z 17/B Z 16/B
ND 25	-	Z 32	Z 39	Z 57	Z 45	Z 51	

# Magnetic level gauge

## Type 810 Floats

Standard 316L St. St.		
Coding	M1/.	M2/.

Body	Material: 316L Stainless Steel Ø 48 mm L=262 ± 0,5 mm	
Magnets	Ferritic ring	Samarium Cobalt
Temperature	Up to +200°C	Up to +350°C
Specific gravity	M1/1 0,75 < sg < 0,86 M1/2 0,87 < sg < 1,03 M1/3 1,04 < sg < 1,2	M2/1 0,75 < sg < 0,86 M2/2 0,87 < sg < 1,03 M2/3 1,04 < sg < 1,2
Weight	285±5 g	
Pressure Rating	20 bar @ 20°C	
Pressure test	30 bar	

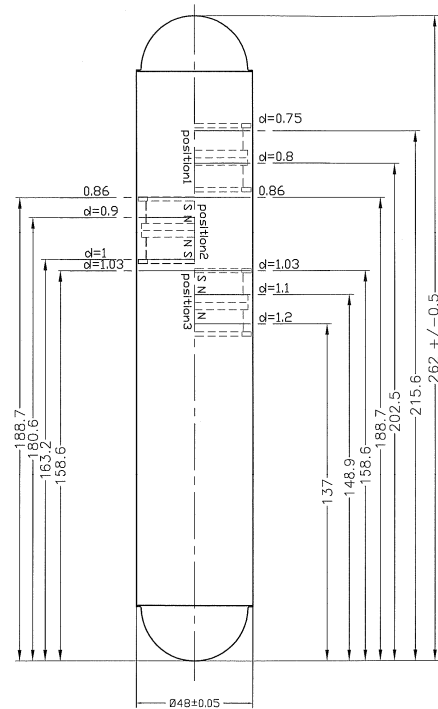
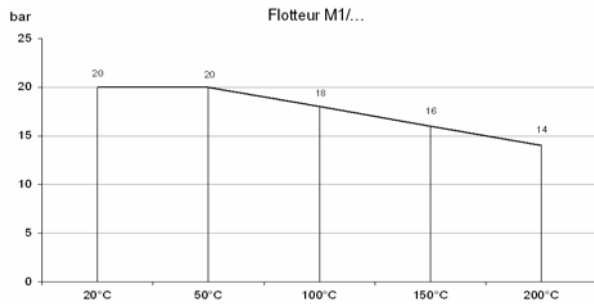

Titanium Gr2	
Coding	M3/.

Body	Material: Titanium Grade 2 Tube Tube Ø 50,8 mm L=250 ± 0,5 mm
Magnets	Ferritic ring
Temperature	Up to +200°C
Specific gravity	M3/1 0,8 < sg < 0,95 M3/2 0,95 < sg < 1,1 M3/3 1,1 < sg < 1,3
Weight	M3/1 356±5 g M3/2 356±5 g M3/3 411±5 g
Pressure Rating	65 bar @ 20°C
Pressure test	102 bar

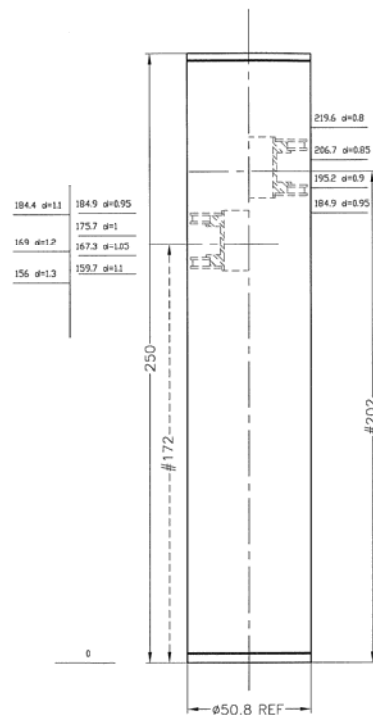
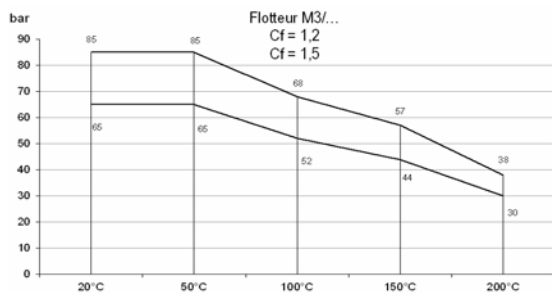



**Type 810**  
**Floats**

**Titanium Gr2**  
**Coding M5/...**

<b>Body</b>	Material: Titanium Grade 2 Tube Tube Ø 50,8 mm L=250 ± 0,5 mm
<b>Magnets</b>	Samarium Cobalt
<b>Temperature</b>	Up to + 350°C
<b>Specific gravity</b>	M5/1 0,74 < sg < 0,8 M5/2 0,8 < sg < 0,93 M5/3 0,93 < sg < 1,05 M5/4 1,05 < sg < 1,2
<b>Weight</b>	M5/1 306±5 g M5/2 306±5 g M5/3 345±5 g M5/4 390±5 g
<b>Pressure Rating</b>	65 bar @ 20°C
<b>Pressure test</b>	102 bar

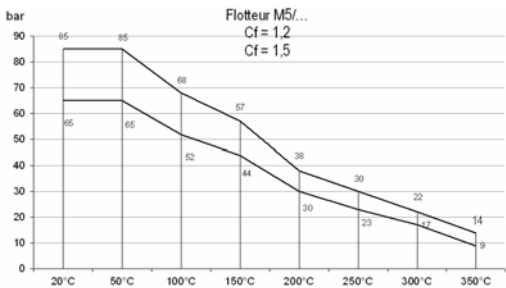
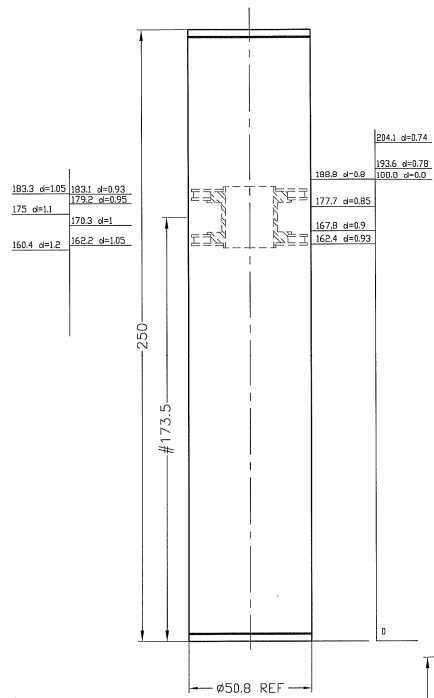

**Titanium Gr2**  
**Coding M6 M7**

<b>Body</b>	Material: Titanium Grade 2 Tube Tube Ø 50,8 mm L=250 ± 0,5 mm	L=350 ± 0,5 mm
<b>Magnets</b>	Samarium Cobalt	
<b>Temperature</b>	Up to + 350°C	
<b>Specific gravity</b>	0,65 < sg < 0,75	0,55 < sg < 0,65
<b>Weight</b>	290g (sg =0,8) 274g (sg =0,74)	342,5g (sg =0,75) 326g (sg =0,67)
<b>Pressure Rating</b>	20 bar @ 20°C	
<b>Pressure test</b>	25 bar	

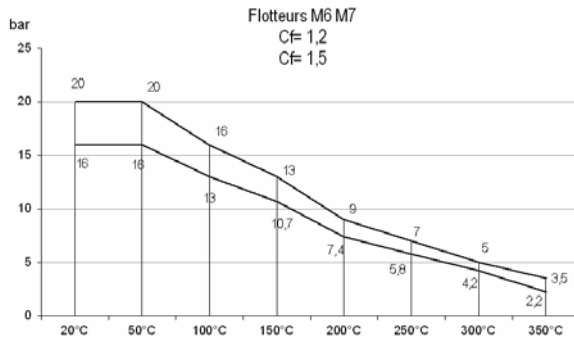
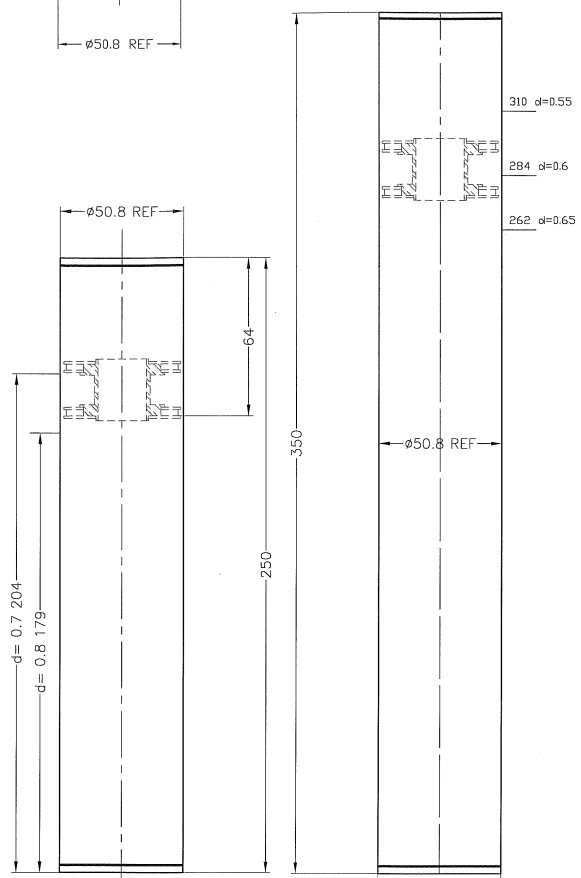

# Magnetic level gauge

## Type 810 Floats

Titanium Gr2		
Coding	M8	M9

Body	Material: Titanium Grade 2 Tube Tube Ø 50,8 mm L=350 ± 0,5 mm	
Magnets	Samarium Cobalt	
Temperature	Up to + 350°C	
Specific gravity	0,67 < sg < 0,75	0,6 < sg < 0,67
Weight	380g	
Pressure Rating	85 bar @ 20°C	
Pressure test	102 bar	

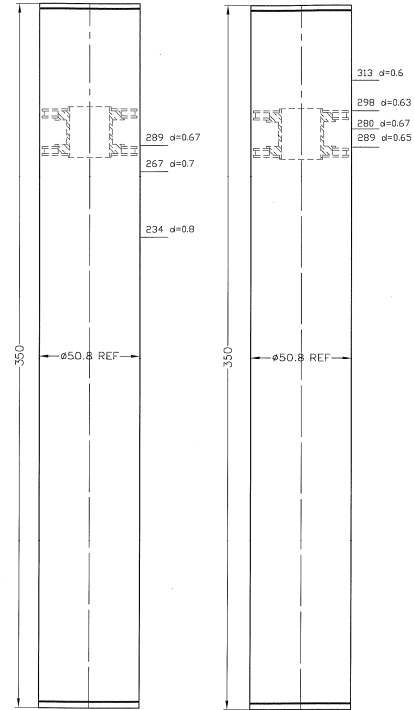
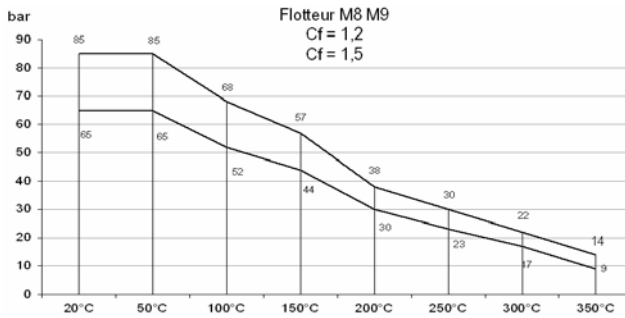

Titanium Gr2		
Coding	M60	M61

Body	Material: Titanium Grade 2 Tube Tube Ø 50,8 mm L=360 ± 0,5 mm	
Magnets	Samarium Cobalt	
Temperature	Up to + 350°C	
Specific gravity	0,52 < sg < 0,56	0,56 < sg < 0,6
Weight	330g	354g
Pressure Rating	40 bar @ 20°C	
Pressure test	60 bar	

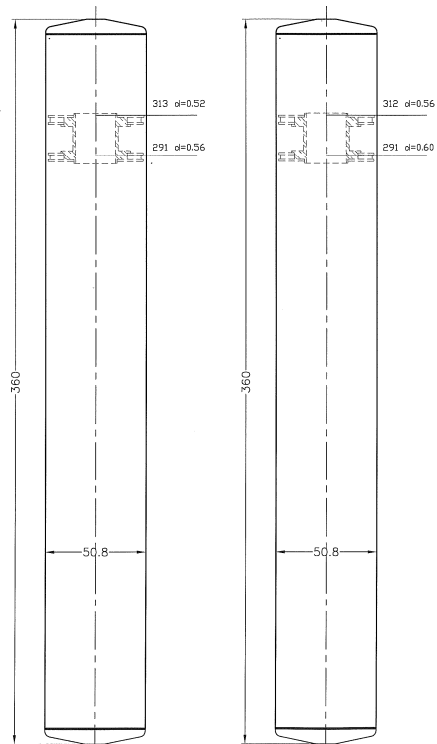
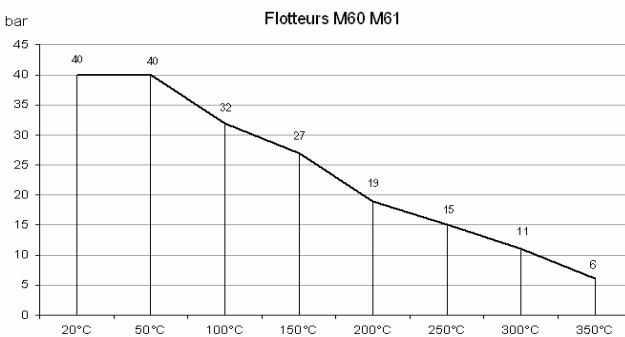

**Type 810  
 Floats**

Titanium Gr5		
Coding	M10	M11
Body	Material: Titanium Grade 5 machined / turned $\varnothing$ 54,5 mm L = 452 ± 0,5 mm      L = 378 ± 0,5 mm	
Magnets	Samarium Cobalt	
Temperature	Up to + 400°C	
Specific gravity	0,535 < sg < 0,57	0,57 < sg < 0,635
Weight	491g	424g
Pressure Rating	140 bar @ 20°C	
Pressure test	210 bar	

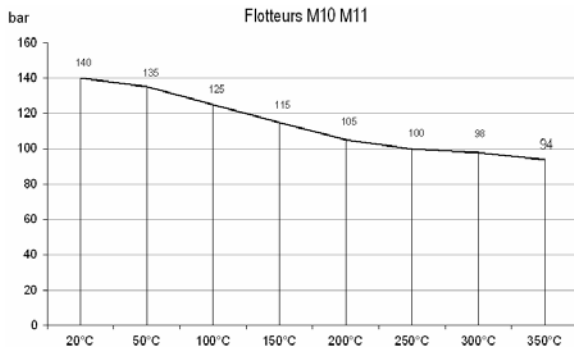
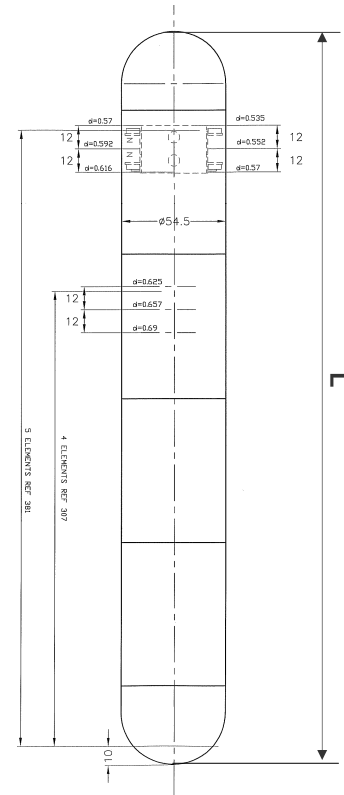

Titanium Gr5								
Coding	M12		M13		M14		M15	
Body	Material: Titanium Grade 5 machined / turned Tube $\varnothing$ 54,5 mm							
Length L	378 ± 0,5 mm		304 ± 0,5 mm		230 ± 0,5 mm		156 ± 0,5 mm	
Bits Qty	5		4		3		2	
Magnets	Samarium Cobalt							
Temperature	Up to + 350°C							
Specific gravity	0,6 ⇒ 0,65	0,58 ⇒ 0,6	0,67 ⇒ 0,73	0,65 ⇒ 0,67	0,785 ⇒ 0,903	0,726 ⇒ 0,785	1,05 ⇒ 1,18	0,904 ⇒ 1,05
Weight	471g		404g		337g		270g	
Pressure Rating	140 bar @ 20°C							
Pressure test	210 bar							

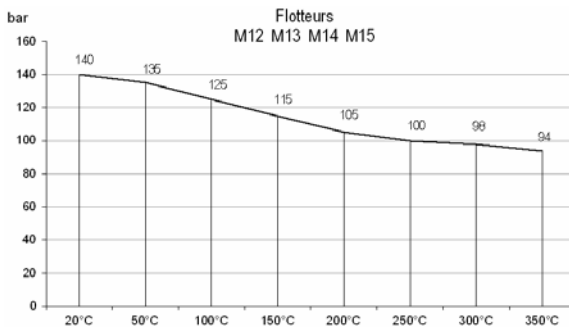
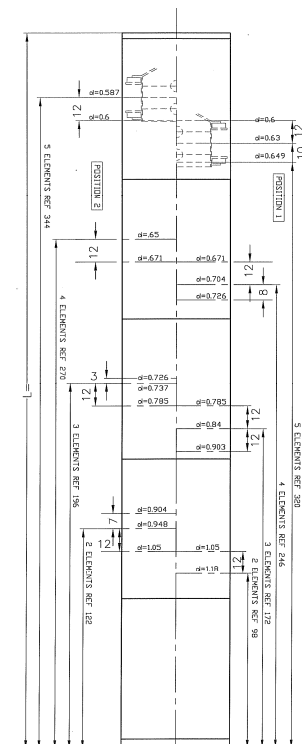

# Magnetic level gauge

## Type 810 Floats

Titanium Gr5								
Coding	M20		M21		M22		M23	
	M20/1	M20/2	M21/1	M21/2	M22/1	M22/2	M23/1	M23/2
Body	Material: Titanium Grade 5 machined / turned Tube Ø 54,5 mm							
Length L	378 ± 0,5 mm		304 ± 0,5 mm		230 ± 0,5 mm		156 ± 0,5 mm	
Bits Qty	5		4		3		2	
Magnets	Samarium Cobalt							
Temperature	Up to + 350°C							
Specific gravity	0,737⇒ 0,78	0,711⇒ 0,736	0,808⇒ 0,876	0,772⇒ 0,807	0,934⇒ 1,043	0,877⇒ 0,933	1,319⇒ 1,38	1,042⇒ 1,32
Weight	571g		486g		401g		316g	
Pressure Rating	240 bar @ 20°C							
Pressure test	360 bar							

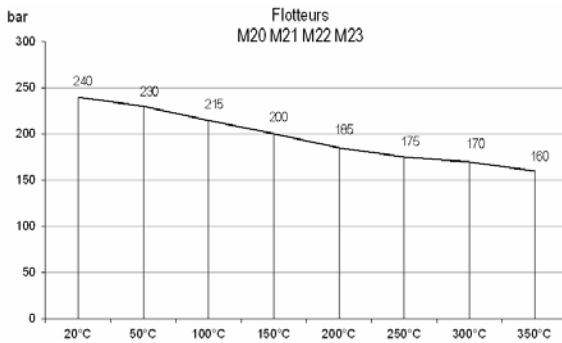
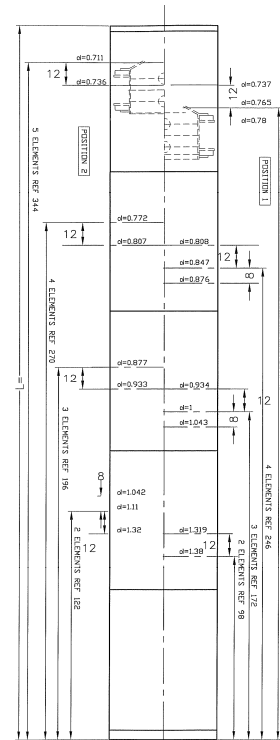

Titanium Gr5			
Coding	M40	M41	M45
Body	Material: Titanium Grade 5 machined / turned Ø 54,5 mm		
Length L	452 ± 0,5 mm	378 ± 0,5 mm	498 ± 0,5 mm
Bits Qty	2	3	3
Magnets	Samarium Cobalt		
Temperature	Up to + 400°C		
Specific gravity	0,52 < d < 0,6	0,43 < d < 0,52	0,4 < d < 0,43
Weight	375g	485g	410g
Pressure Rating	140 bar @ 20°C		40 bar @ 20°C
Pressure test	210 bar		60 bar

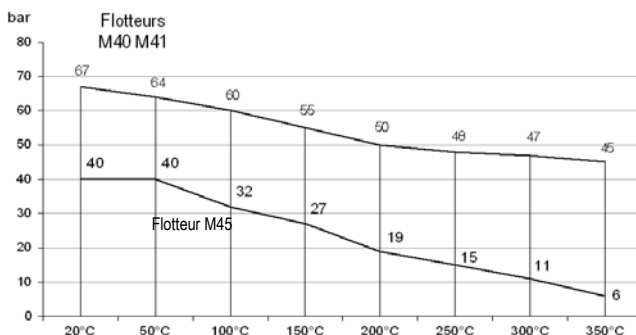
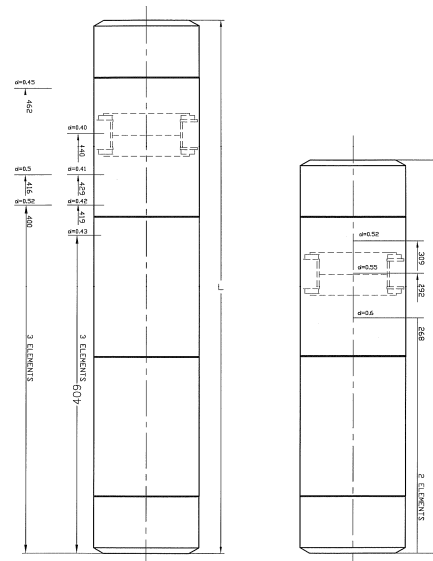

## Type 810 Floats Buoyancy range

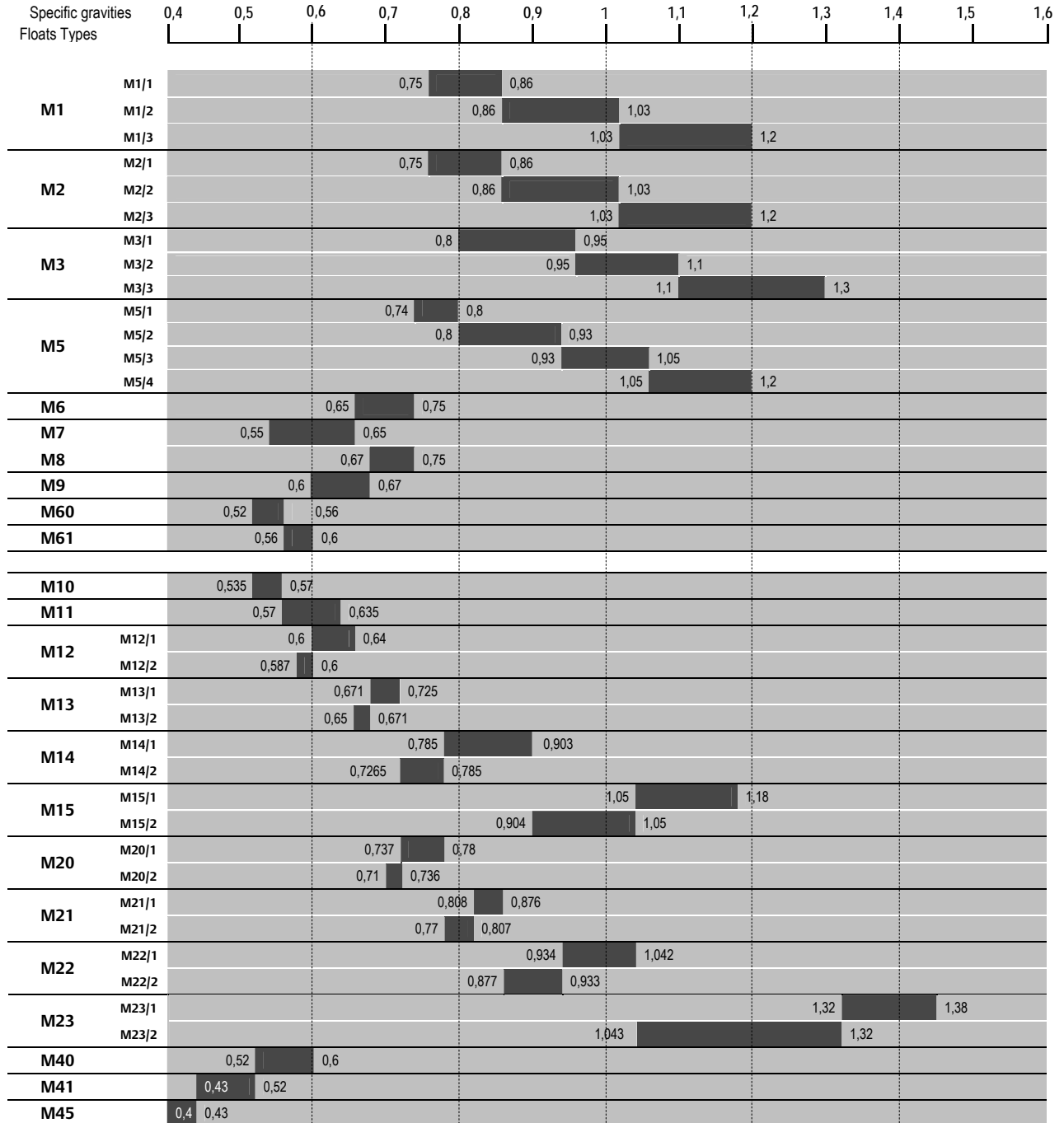

- Customised float at exact SG setting with calibration certificate available on request
- Interface application – please specify upper/lower liquid SG + approx liquid thickness.

# Magnetic level gauge

## Type 810 4-20mA Output / Level transmitter

Each level gauge can be equipped with a magnetic transmitter for remote measuring and continuous indication. A stainless steel tube protects a PCB fitted with reed-contact parts. This potentiometric line is driven by the float of the level gauge.  
The transmitter housing is IP65 in standard, EExia (IS) or flame-proof (EExd) on request. The level transmitter option for level gauges type 810 could be fitted either for slider or flaps indicator type versions. It is simply jubilee-clip mounted against the main body tube of the instrument and could be connected and wired using its top housing/cable gland.

Design	
Type	4-20mA Transmitter
Dimensions (LxIxh)	See drawing
Rod	Ø 14mm 316L St. St.
Housings	Aluminium IP65 as standard Aluminium Explosion proof "d" Aluminium IS "ia" 316L St. St.
Top design	Vertical design as standard 90° as an option (see below)
Mounting	Stainless Steel Jubilee clips
Transmitter Electrical Units	XT42 Standard XT42 ATEX IS. "ia" XTpro-HART XTpro-HART ATEX IS "ia" XTpro-HART LIN XTpro-HART LIN ATEX IS. "ia"
Range max.	5,5m
Resolution	15mm
Protection	IP65 – IP67
Max Temperature	300°C (Insulation required from +150°C)

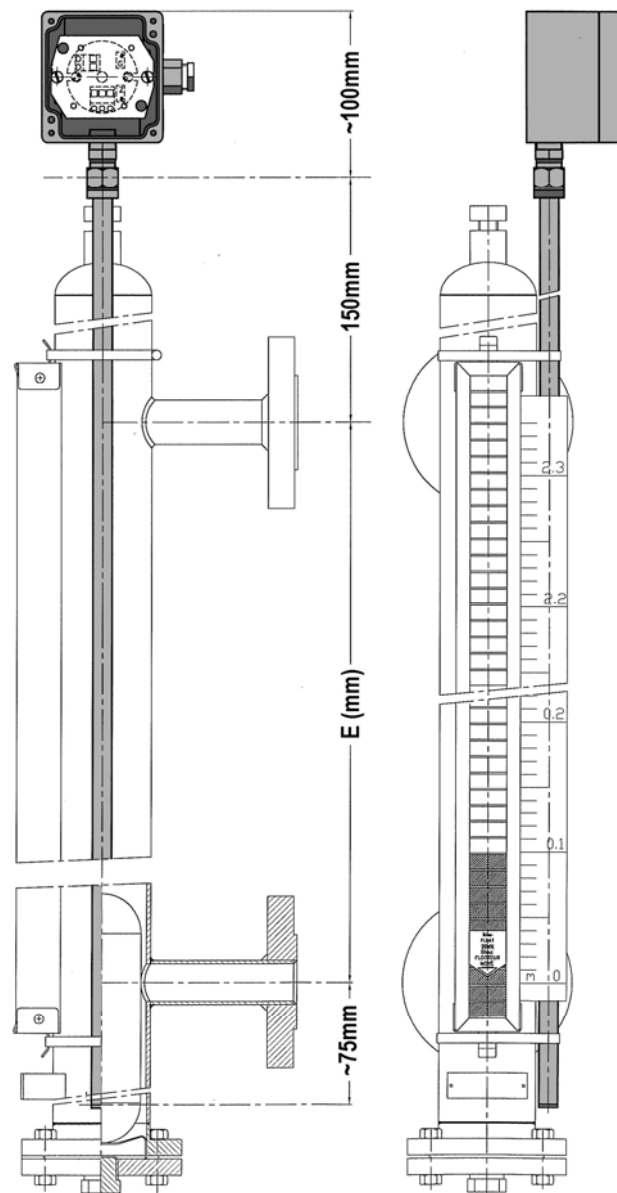
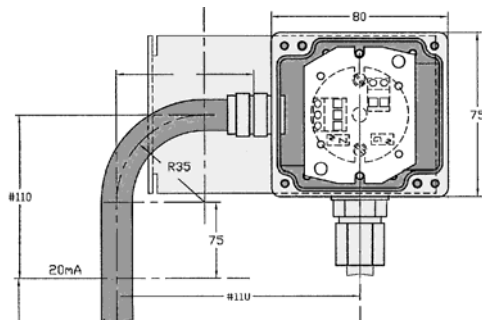

## Type 810 4-20mA Output / Level transmitter

Housings selection	
Type	Standard IP65
Dimensions (LxHxh)	80mm x 75mm x 57mm
Material	Aluminium
Rod	Ø 14mm 316L St. St. on ¼" NPT brass connection
Connection	PG9 Polyamid cable gland for Ø 5 à 9mm cables
Protection	IP65 – 4 screws cover
Coating	Polyester paint

Type	B4 – Explosion proof ("d")
Dimensions (LxHxh)	See below drawing
Material	Aluminium
Rod	Ø 14mm 316L St. St. ¼" NPT
Connection	¼"NPT Aluminium cable gland (Ø 5 à 12mm cables) (supplied) ATEX certified ("d")
Protection	IP65/IP66 – screwed cover
Coating	No – Raw Aluminium finish
Certificate	ATEX N° LCIE01ATEX6060X
Marking***	⊕ II 2G EExdIICT6
Electrical data	Supply Max.: 230V Current Max.: 15A Power Max.: 20W
Temperature	Ta = -40°C = +75°C
Name plate	Aluminium / St. St rivets

Type	Intrinsically safe ("ia")*
Dimensions (LxHxh)	See below drawing
Rod	Ø 14mm 316L St. St. on ¼" NPT brass connection
Connection	PG9 Polyamid blue cable gland for Ø 5 à 8 m cables (EExe certified)
Protection	IP65
Coating	Polyester paint
Certificate	ATEX N° LCIE05ATEX6034X
Marking **	⊕ II 1 G EExialICT6/T5/T4
Electrical data	Ui≤30V; Ii≤101mA; Pi≤758mW Or Ui≤28,4V; Ii≤116mA; Pi≤824mW Ci=0nF ; Li=0mH
Temperature	T6: Ta=50°Cmax./ T5:Ta=65°Cmax./ T4: Ta=80°Cmax.
Plaque signalétique	Aluminium / St. St rivets

Type	ISA - 316L St. St.
Dimensions (Øxh)	Ø 103mm, h=117mm
Rod	Ø 14mm 316L St. St.
Connection	M20x1,5 cable gland (cables Ø 5 à 9mm)
Protection	IP67– screwed cover
Coating	No - Raw Stainless steel finish
<i>Explosion proof "d" certified version</i>	
Marking ***	⊕ II 2G EExdIICT6
Certificate	ATEX "d"
Connection	M20x1,5 cable gland "d" certified
Protection	IP67– screwed cover
Coating	No - Raw Stainless steel finish

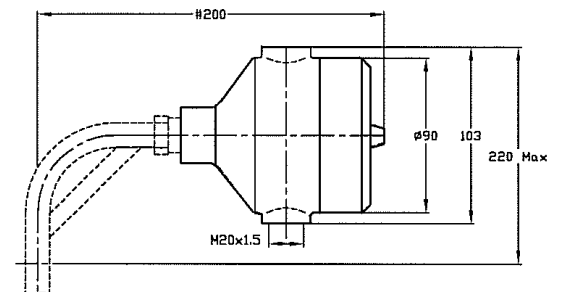
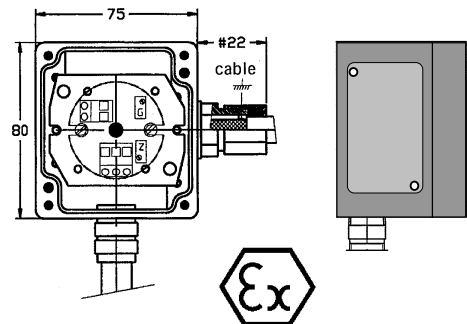
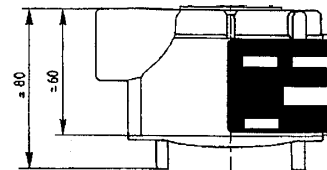
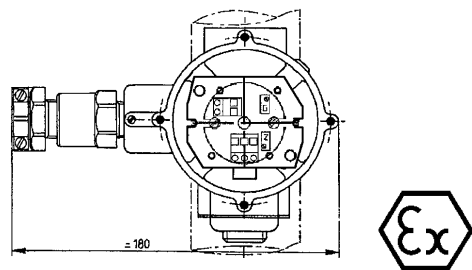
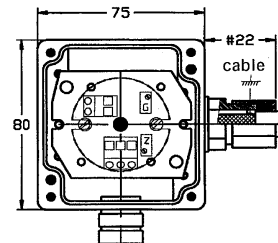

\* The transmitter electrical unit must be chosen among the ATEX IS certified units (see next page)  
\*\* The ATEX marking complies with the 94/09/EC Directive and certify the transmitter, the reed switch line and the housing.  
\*\*\* The ATEX marking complies with the 94/09/EC Directive and certify the reed switch line and the housing

# Magnetic level gauge

**Data Sheet**  
DS-MLG-810-eng  
June, 2008

## Type 810 4-20mA Output / Level transmitter

Transmitter range	
Type	XT42-NIV (standard)
Output	4-20mA 2 wires
Maximum Range	5,5 m
Power supply	12V < V < 30V
Temperature	-20°C < T < 70°C
Accuracy	0,15% full scale
Resolution	15mm

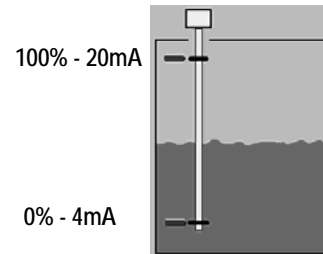

Type	
Type	XT42-NIV I.S.
Output	4-20mA 2 wires
Maximum Range	5,5 m
Power supply	12V < V < 30V
Temperature	-20°C < T < 65°C
Accuracy	0,15% full scale
Resolution	15mm

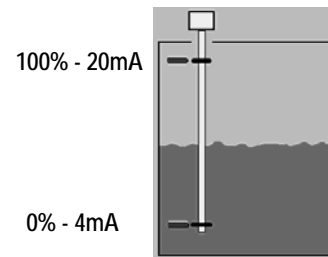
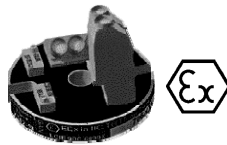

Types	
Type	XT PRO-HART XT PRO-HART LIN

Output	4-20mA 2 wires
Maximum Range	5,5 m
Power supply	9,5V < V < 30V
Temperature	-20°C < T < 70°C
Accuracy	0,1% full scale
Resolution	15mm
Protocol	HART
Data Acquisition	10/s
Burnout	3,8mA / 22mA
Linearization	XTPRO LIN version only

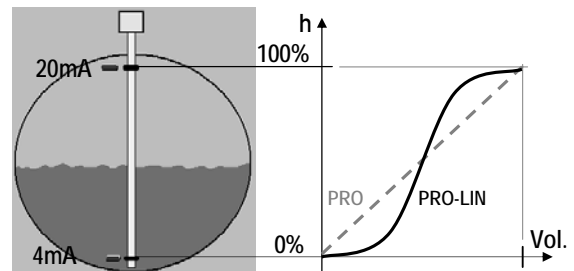
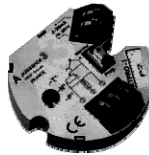

Types	
Type	XT PRO-HART S.I. XT PRO-HART LIN S.I.

Output	4-20mA 2 wires
Maximum Range	5,5 m
Power supply	9,5V < U < 30V
Temperature	-20°C < T < 65°C
Accuracy	0,1% full scale
Resolution	15mm
Protocol	HART
Data Acquisition	10/s
Burnout	3,8mA / 22mA
Linearization	XTPRO LIN version only
ATEX certified	Intrinsically safe EExia

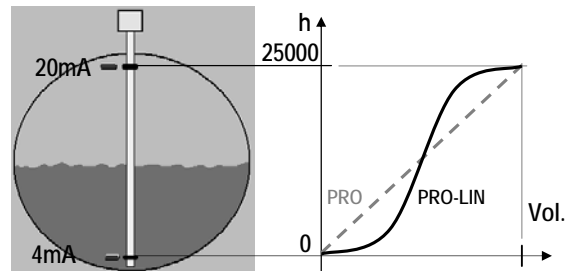



## Type 810 4-20mA Output / Level transmitter

### Transmitter option coding

#### Code

#### Aluminium housing range

##### *Vertical end top design*

<b>T1</b>	XT42-NIV	Standard IP65	-
<b>T2</b>	XT42 "ia"	Standard IP65	ATEX "ia"
<b>T4</b>	XT42-NIV	B4	ATEX "d"
<b>T5</b>	XT pro - HART	Standard IP65	-
<b>T6</b>	XT pro - HART "ia"	Standard IP65	ATEX "ia"
<b>T7</b>	XT pro - HART	B4	ATEX "d"
<b>T9</b>	XT pro - HART LIN	Standard IP65	-
<b>T10</b>	XT pro - HART LIN "ia"	Standard IP65	ATEX "ia"
<b>T11</b>	XT pro - HART LIN	B4	ATEX "d"

##### *90° end top design*

<b>T1/C</b>	XT42-NIV	Standard IP65	-
<b>T2/C</b>	XT42 "ia"	Standard IP65	ATEX "ia"
<b>T4/C</b>	XT42-NIV	B4	ATEX "d"
<b>T5/C</b>	XT pro - HART	Standard IP65	-
<b>T6/C</b>	XT pro - HART "ia"	Standard IP65	ATEX "ia"
<b>T7/C</b>	XT pro - HART	B4	ATEX "d"
<b>T9/C</b>	XT pro - HART LIN	Standard IP65	-
<b>T10/C</b>	XT pro - HART LIN "ia"	Standard IP65	ATEX "ia"
<b>T11/C</b>	XT pro - HART LIN	B4	ATEX "d"

#### 316L St. St. Housing range

##### *Vertical end top design*

<b>T20</b>	XT42-NIV	ISA 316L St.St.	-
<b>T21</b>	XT42 "ia"	ISA 316L St.St.	ATEX "ia"
<b>T22</b>	XT42-NIV	ISA 316L St.St.	ATEX "d"
<b>T23</b>	XT pro - HART	ISA 316L St.St.	-
<b>T24</b>	XT pro - HART "ia"	ISA 316L St.St.	ATEX "ia"
<b>T25</b>	XT pro - HART	ISA 316L St.St.	ATEX "d"
<b>T26</b>	XT pro - HART LIN	ISA 316L St.St.	-
<b>T27</b>	XT pro - HART LIN "ia"	ISA 316L St.St.	ATEX "ia"
<b>T28</b>	XT pro - HART LIN	ISA 316L St.St.	ATEX "d"

##### *90° end top design*

<b>T20/C</b>	XT42-NIV	ISA 316L St.St.	-
<b>T21/C</b>	XT42 "ia"	ISA 316L St.St.	ATEX "ia"
<b>T22/C</b>	XT42-NIV	ISA 316L St.St.	ATEX "d"
<b>T23/C</b>	XT pro - HART	ISA 316L St.St.	-
<b>T24/C</b>	XT pro - HART "ia"	ISA 316L St.St.	ATEX "ia"
<b>T25/C</b>	XT pro - HART	ISA 316L St.St.	ATEX "d"
<b>T26/C</b>	XT pro - HART LIN	ISA 316L St.St.	-
<b>T27/C</b>	XT pro - HART LIN "ia"	ISA 316L St.St.	ATEX "ia"
<b>T28/C</b>	XT pro - HART LIN	ISA 316L St.St.	ATEX "d"

- Possibility to offer magnetostrictive transmitters. Will be shown on technical datasheet very shortly.

# Magnetic level gauge

## Type 810 Alarm contacts

Each level gauge could be equipped with alarm contacts. Fitted along the main tube, they are adjusted to switch on as the liquid rise or fell to the chosen level. The contact housing is IP65 in standard, ATEX "ia" or Explosion-proof (EExd) on request.

The alarm contact option for level gauges type 810 could be fitted either for slider or flaps indicator type versions. It is simply collar-mounted against the main body tube of the instrument and could be connected and wired using its housing/cable gland.

NOTA : For each contact, a position (height) should be given to perform factory setting. Otherwise, contacts are simply fitted on tube to be adjusted by the customer himself.

Single reed switch IP65		
Coding	S1	S6
Dimensions (Lxlxh)	80mm x 75mm x 57mm	
Material	Aluminium	
Switch	Single Reed switch (see below diagram)	
Connection	PG9 Polyamid cable gland (cables Ø 5 to 9mm)	
Protection	IP65 – 4 screws cover	
Coating	Polyester paint	
Max. Power supply	230V	
Max. Power	60W/ 60VA	
Temperature	200°C Max.	300°C Max.

As option **S20**: "Tropicalization" for corrosive/ wet atmospheres

Single / dual reed switch "d" ATEX Explosion proof		
Coding	S2	S4
Dimensions (Lxlxh)	80mm x 75mm x 57mm	
Material	Aluminium	
Switch	Single Reed switch   Dual Reed switch	
Connection	¾"NPT Aluminium cable gland (cables Ø 5 to 12mm) (supplied) ATEX explosion proof ("d") certified	
Protection	IP65/66 – Screwed cover	
Coating	No – Raw aluminium finish	
Max. Power supply	230V	
Max. Power	60W/ 60VA	
Certificate	ATEX N° LCIE01ATEX6060X	
Marking***	EEx II 2G EExdIICT6	
Electrical data (EC certificate)	Max. supply : 230V Max. current: 15A Max. power : 20W	
Temperature	Ta = - 40°C to +75°C	
Name plate	Aluminium / St.St. rivets	

As option **S20**: "Tropicalization" for corrosive / wet atmospheres

Dual reed switch IP65		
Coding	S3	S7
Dimensions (Lxlxh)	80mm x 75mm x 57mm	
Material	Aluminium	
Switch	Dual Reed switch (see below diagram)	
Connection	PG9 Polyamid cable glands (cables Ø 5 to 9m)	
Protection	IP65 – 4 screws cover	
Coating	Polyester paint	
Max. Power supply	230V	
Max. Power	60W/ 60VA	
Temperature	200°C Max.	300°C Max.

As option **S20**: "Tropicalization" for corrosive / wet atmospheres

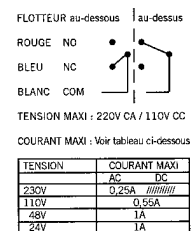
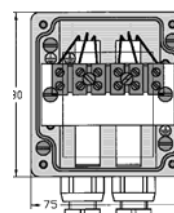
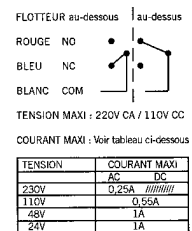
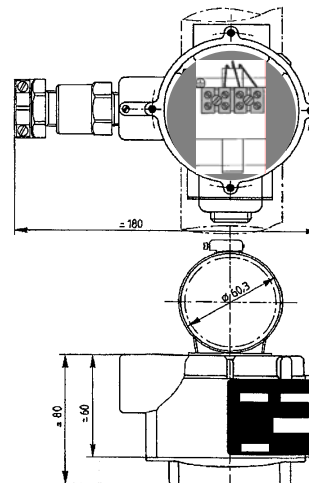
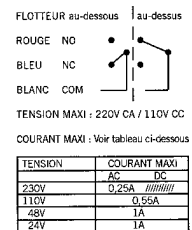
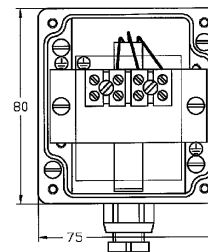

\*\* The ATEX marking complies with the 94/09/EC Directive and certify, the reed switch and the housing.  
\*\*\* The ATEX marking complies with the 94/09/EC Directive and certify the housing.

## Type 810 Alarm contacts

Basic Reed switch assembly	
Coding	S5
Dimensions (LxIxh)	75mm x 15mm x 15mm
Material	Aluminium
Switch	Reed switch (see below diagram)
Connection	3m electrical cable
Protection	IP65
Coating	No – raw aluminium housing finish
Max. Power supply	230V
Max. Power	60W/ 60VA
Temperature	-20°C < T < 80°C Max.

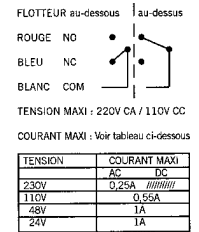

Single / dual reed switch "ia" ATEX intrinsically safe		
Coding	S8	S9
Dimensions (LxIxh)	80mm x 75mm x 57mm	
Material	Aluminium	
Switch	Single Reed switch	Dual Reed switch
Connection	PG9 Polyamid Blue cable gland (cables Ø 5 to 8mm) EExe certified	
Protection	IP65 – 4 screws cover	
Coating	Polyester paint	
Certificate	ATEX N° LCIE05ATEX6034X	
Marking**	II 1 G EExiaICT6/T5/T4	
Electrical data	$U_i \leq 30V$ ; $I_i \leq 101mA$ ; $P_i \leq 400mW$ $C_i = 0nF$ ; $L_i = 0mH$	
Temperatures	T6: $T_a = 50^\circ C_{max}$ / T5: $T_a = 65^\circ C_{max}$ / T4: $T_a = 80^\circ C_{max}$ .	
Name plate	Aluminium / St.St. rivets	

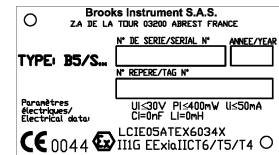
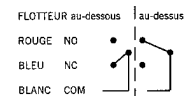
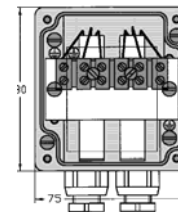

As option **S20**: "Tropicalization" for heavy/ wet atmospheres

Pneumatic switch N/O – N/F		
Coding	S21	S22
Dimensions H x d	120mm x Ø 80mm	
Material	316L St.St.	
Switch	"Normally open"	"Normally closed"
	1: Input 2: Output 3: Exhaust	1: Input 2: Output 3: Exhaust
Connection size	3 input/output 0°/ 45°/ 90° 1/4" NPT	
Coating	NO – Raw stainless steel finish	
Pressure range	2 to 6 bars	
Mounting	2 jubilee clips against the chamber	
Temperature	-15°C < T < 60°C	

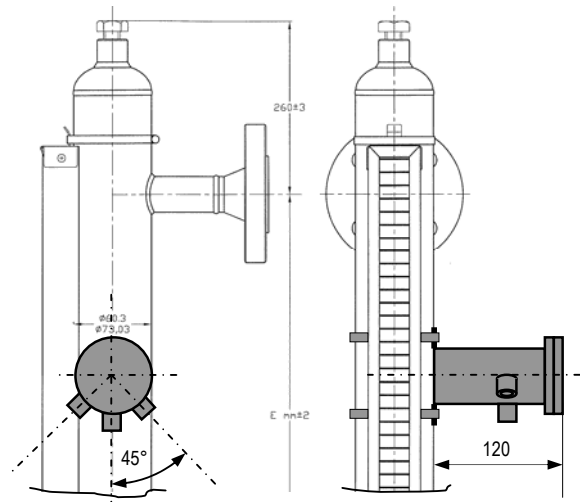

\*\* The ATEX marking complies with the 94/09/EC Directive and certify, the reed switch and the housing.

# Magnetic level gauge

## Type 810 Documentations

Description			
Code		Standard	High Dirty
D12	General Drawing (included in D4A)	X	X
D13	Certificate package (included in D4A) - certificate of conformity to the orde - Pressure test certificate - Material 2.2 certificate	X	X
D0	Material certificate 3.1.B (regarding the chamber)	X	X
D1	NACE MR-01-75 compliance certificate		X
D2	Welding book according to CODAP standard		X
D3	Calculation note		X
D4A	Complete PED certificates and documentation package - General Drawing - Conformity + Pressure test certificate - Description - Calculation note - Material certificates 3.1.		X
D6	Dy Penetrant test certificate "Brooks Instrument" (performed by Brooks Instrument)	X	X
D7	10% Dye penetrant test for welds "CertifiedOrganism" (performed by an accredited Notified body)	X	X
D7	20% Dye penetrant test for welds "CertifiedOrganism" (performed by an accredited Notified body)		X
D8	10% Welds X-ray examination certificate	X	X
D8	20% Welds X-ray examination certificate		X
D9	100% Welds X-ray examination certificate		X
D10	Thickness control certificate ("0" point)		X
D11	documentation Cd-rom	X	X
	PMI testing on request		X
	DIRECTIVE DESP 97.23-CE		
	* Gaz groupe 1	According the model	X
	* Gaz groupe 2	X	X
	Code de construction CODAP 2005 div1	X	
	CODAP 2005 div2		X

These instruments going designed under classification: vessel under pressure component as gas located over the liquid to measure







# Magnetic level gauge

---

**Data Sheet**  
DS-MLG-810-eng  
June, 2008

**Brooks Instrument S.A.S.**  
Z.A. de la Tour- ABREST- France  
Tel: +33 (0)4.70.59.81.81.  
Fax: +33 (0)4.70.59.96.37.  
[www.Brooksinstrument.com](http://www.Brooksinstrument.com)

---

© Copyright 2008 Brooks Instrument, LLC All rights reserved.

**BROOKS**<sup>®</sup>  
INSTRUMENT